

Comprehensive solutions
to meet and exceed the unique and
wide-ranging requirements



Powering Business Worldwide

EAT•N

The power of fusion.

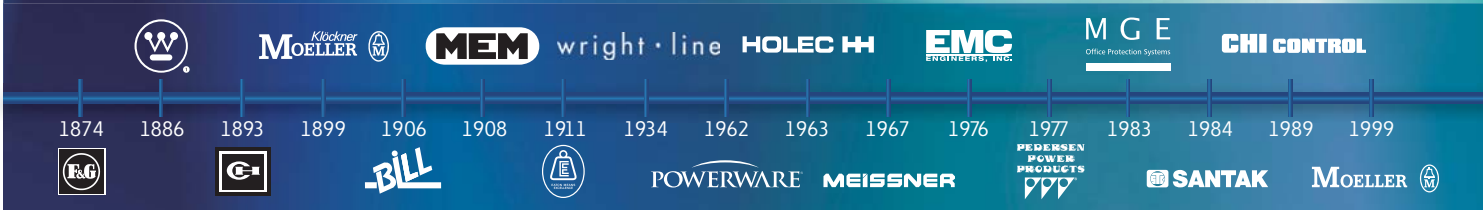

EAT•N

Powering Business Worldwide

There's a certain energy at Eaton. It's the power of uniting some of the world's most respected names to build a brand you can trust to meet every power management need. The energy created supports our commitment to powering business worldwide.

Eaton is dedicated to ensuring that reliable, efficient and safe power is available when it's needed most. With unparalleled knowledge of electrical power management across industries, experts at Eaton deliver customized, integrated solutions to solve our customers' most critical challenges. Eaton.com/SEAsia

All of the above are trademarks of Eaton Corporation or its affiliates. Eaton has a license to use the Westinghouse brand name in Asia Pacific. ©2013 Eaton Corporation.

Low Voltage Air Circuit Breakers

IZM Series



Low Voltage Air Circuit Breakers IZM Series

1

IZM Series NES Type

2

IZM Series MWI Type

3

Low Voltage Air Circuit Breakers

Low Voltage Air Circuit Breakers IZM Series

1

IZM Series



1.1 Low Voltage Air Circuit Breakers IZM Series

Features, Benefits and Function	2
Greater safety for maintenance personnel with Arcflash Reduction Maintenance System™.....	3

Low Voltage Air Circuit Breakers IZM Series

Product Overview

Eaton Low Voltage Power Circuit Breakers for Global Application

Eaton Low Voltage Air Circuit Breakers enable comprehensive solutions to meet and exceed the unique and wide-ranging requirements of today's global power distribution systems. This powerful circuit breaker offering is designed for ultimate custom configuration and application flexibility, with the needs of the power distribution equipment user and the electrical equipment manufacturer in mind.

Product Families

IZM Series Air circuit breakers consist of two product families:

NES Type

200A-1600A, 42kA / 50kA / 65kA

MWI Type

800A-6300A, 65kA / 85kA / 100kA

Each provides specific ratings features and approvals to optimize performance when applied in power distribution equipment and custom enclosures.

IZM Series Air Circuit Breakers for IEC Rated Switchboards

- Up to 690 Vac
- 200 to 6300A continuous
- 42 to 100 kA I_{cu}/I_{cs}



IZM Series Low Voltage Air Circuit Breaker Family

Features, Benefits and Function

- **High interruption ratings** with current limiting performance and low current let-through to reduce damaging energy to downstream equipment at high fault levels
- **Withstand ratings up to high interruption ratings** to maximize system coordination and selectivity
- **Three physical frame sizes** (Compact, Standard and Double) to promote breaker application in compact modular enclosures and improve enclosure density
- **Continuous current ratings from 200 to 6300A** with 100% rating at 104°F (40°C) and no derating on most ratings up to 122°F (50°C)
- **Fixed breaker mounting configurations** with horizontal and optional vertical and front connected terminal connections
- **Drawout breaker mounting configurations** with cassette and optional safety shutters
- **Three- and four-pole breaker configurations**
- **Through-the-door design** for human interface with the breaker compartment door closed
- **Two-step stored energy mechanism** for manually and electrical operated breakers
- **Digitrip™ RMS Trip Unit family protection** with different models each providing increasing levels of protection and feature options for coordination, information and diagnostics:
 - Microprocessor-based rms sensing
 - Basic to programmable overcurrent protection and alarms
 - Local display for information, status and diagnostics
 - Ampere, voltage and power metering
 - Power quality, harmonics and waveform capture
 - Communications with translators to common protocols
 - Zone selective interlocking for improved coordination
 - Integral Arcflash Reduction Maintenance System™
 - Breaker health monitoring
- **Field-installable accessories** common across the breaker frames and designed to be easily installed in the field to service or modify the breaker at the point of use
- **Secondary terminal contacts** mounted at the top front of the breaker and away from the primary voltage areas for improved safety and access. Finger-safe terminal blocks accommodate ring-tongue or spade type terminals as standard



Through-the-Door Design for Human Interface with the Breaker Compartment Door Closed



High Technology Microprocessor-Based Digitrip RMS 1150+ Trip Units are Available With Advanced Features Like Programmable Overcurrent Settings, Power Metering, Power Quality and Communications

1.1

Low Voltage Air Circuit Breakers Low Voltage Air Circuit Breakers IZM Series

1 Greater safety for maintenance personnel with Arcflash Reduction Maintenance System™

Personnel safety is of paramount importance in today's work environment. Of recent concern is the potential for serious injury due to exposure to electrical arcs. Eaton's IZM Series trip units offer the patented Arcflash Reduction Maintenance System™, which offers a non-delayed immediate disconnection in the event of an arc fault. This disconnection is even faster than that of a nondelayed short-circuit release. This function can be activated directly on the circuit-breaker or via an external switch when maintenance personnel enters a hazardous area.

Major Benefits of Arcflash Reduction Maintenance System™ :

- Increased personnel safety – by limiting the available arc flash energy
- Simple to operate
- Enabled with circuit breaker door closed by a door mounted lockable switch
- Enabled only for the time required to perform the desired maintenance work
- Preserves overcurrent coordination under normal conditions
- Reduction in incident energy levels may permit reduced levels of Personal Protective Equipment (PPE), therefore improving worker comfort and mobility



Direct ARMS activation on the circuit-breaker



Maintenance of a switchgear system

IZM Series



2.1 Standards and Certifications	
IZM Series NES Type.....	4
2.2 Catalog Number Selection	
IZM Series NES Type.....	7
2.3 Technical Data and Specifications	
IZM Series NES Type.....	12
2.4 Dimensions	
IZM Series NES Type.....	15
2.5 Wiring Diagrams	
IZM Series NES Type.....	16

IZM Series NES Type

Product Description

NES Type is a low voltage air circuit breaker suitable for IEC switchgears and switchboards. The compact size and weight of three-pole drawout with cassette Series NES Type, allows for a 24.00 (609.6 mm) switchgear enclosure.

The breaker ratings are:

- 630–1600A IEC 60947-2 from a voltage range of 220–725 Vac

Application Description

NES Type is a compact globally certified low voltage air circuit breaker. It is rated for 630–1600 amperes (IEC 60947-2) with an interrupting capacity of 65 kA with short time withstand at 42 kA at the 440/480 Vac level.

NES Type circuit breaker provides all the capabilities of a power circuit breaker in the compact size of a molded case breaker. It offers you the same protection and performance—along with increased flexibility—at half the size of a typical power circuit breaker. The dimensions and design of NES Type allows up to eight breakers in a 24-inch (600 mm) wide structure. The one frame size, regardless of ampere rating, reduces drawing conversion, structure integration time and parts inventory for several board, gear and machinery applications.

Features, Benefits and Function

NES Type utilizes several innovative technologies:

- Rogowski coil—does not saturate like iron core sensors, and one sensor accommodates 200–1600 ampere range. You never have to change a sensor and CTs are not required
- Tension clamp secondary terminals mounted directly to fixed breaker or drawout cassette, they reduce wiring throughout enclosure and provide clean, organized wiring schemes
- Breaker-mounted communication modules—communication modules for INCOM™, Modbus® and PROFIBUS mount directly to the cassette, reducing the space and room required in gear for communication capability
- “Direct Drive” mechanism—symmetrically loaded forces of the two-staged stored energy mechanism improves robustness, reliability, and achieves improved breaker life ratings

- Fold-up cassette—with this simple design, all items in a cassette are replaceable without removing the cassette from the cell
- “Arc chute” design
- Breaker-mounted racking or levering-in device—Racking device is mounted on the breaker, decreasing the width of the cassette, because the cassette is not burdened with the cost or parts of the lev-in
- Plug-N-Play accessories—No special tools needed. Accessory comes with plug and wires ready to install

NES Type offers a life of 20,000 mechanical operations and 10,000 electrical operations with a high degree of reliability.

Standards and Certifications

- CEI EN 60947
- BS EN 60439-1 Form 4b
- IEC 60439-1 (low voltage switchgear and controlgear assemblies)
- IEC 60947-1 (low voltage switchgear and controlgear—Part 1 general rules)
- IEC 60947-2 (low voltage switchgear and controlgear—Part 2 circuit breakers)
- IEC 60947-3 (switches, disconnectors, switch-disconnectors and fuse-combination units)

2.1 Low Voltage Air Circuit Breakers

IZM Series NES Type

IZM Series NES Type

2

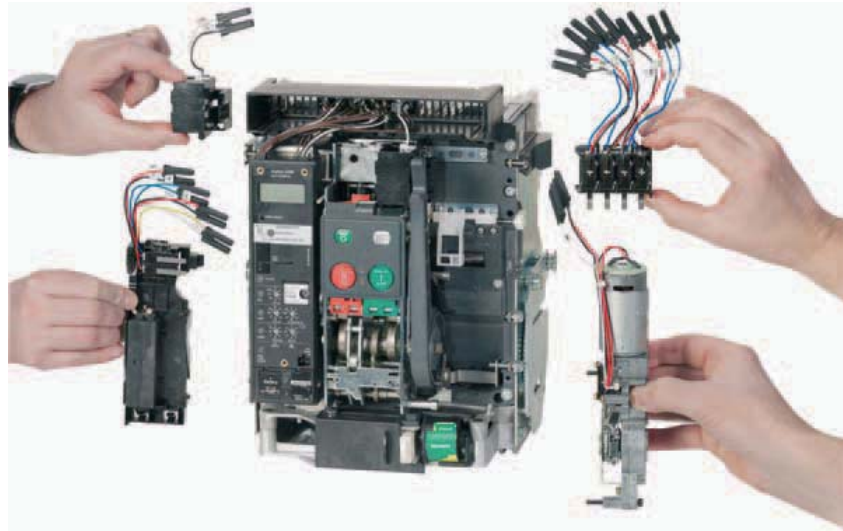

IZM Series NES Type

The innovative concept of the NES Type makes it possible to install two withdrawable circuit-breakers in a 600 mm wide section. This enables more economical section design, and performance in a minimum of space goes far beyond the standard available worldwide.

Applications

The circuit-breakers can be used in four main application areas depending on the type of equipment to be protected:

- System protection,
- Motor protection,
- Transformer protection,
- Transformer protection,

These key applications make different demands on the switches, which are met with a range of control units.

Switches with Closing Release

They are particularly suitable for synchronization tasks.

Coupler Switches

Besides the NES Type circuit-breakers, IN91 switch-disconnectors are available. These are used, for example, as coupler switches between different power supplies.

Modular Design

The retrofitting of accessories is made considerably easy thanks to the efficient "plug & work" technology. Accessory drawers and snap-fit mechanisms make it possible to fit the latest accessories with virtually no tools. This allows you to respond flexibly to changing requirements within your system.

Standard Scope of Delivery as Usual

- With the new NES Type, you select a basic device that is already fitted with an electronic release.
- The standard mounting is on a horizontal mounting plate or on horizontal traverses in the switching cabinet. The NES Type can also be fastened to vertical mounting plates.
- With four-pole devices, the neutral conductor is arranged on the left (front view).
- The neutral conductor can be loaded 100% like the phase conductors.
- The circuit-breakers are provided with a standard mechanical reclosing lockout. After an overload trip, the fault is usually examined first of all. After the fault is identified and rectified, the mechanical reclosing lockout is reset by pressing the red mechanical trip indicator on the front of the circuit-breaker.
- An "Automatic Reset" can be ordered as an option. This enables the circuit-breaker to be restored to operation immediately at any time after the spring-operated stored energy mechanism is retensioned. In these applications compulsory fault analysis is intentionally avoided.
- The number of control cable terminals depends on the accessories fitted.
- If a cassette is ordered without the basic device, this can be already fitted with the maximum number of control cable terminals. For cost effectiveness in plants, the cassette is also offered without control circuit terminals so that fitting can be carried out later at the installation or when the required accessories are determined at a later time.
- 2 changeover contacts are provided as standard for ON/OFF status indication.
- A coding mechanism between the basic device and the cassette prevents impermissible combinations ("Rejection Interlock").

Expanded Standard Scope of Delivery for NES Type

Some order types from the past can no longer be found since the following options are now already part of the standard scope of delivery:

- The door escutcheon is now always included in the scope of delivery. With withdrawable designs this is supplied with the cassette (withdrawable unit).
- On withdrawable units the circuit-breaker can be pulled out to inspect the arc chutes. With fixed units, it is recommended that sufficient space is provided above the circuitbreaker to enable inspection. An additional cover is not required.
- All basic devices that are provided with universal protection (with Digitrip 520M ...), now feature a display.
- On each circuit-breaker the integrated Digitrip electronic release is factory fitted with a sealable protective cover.
- If a motor operator is ordered, the "Spring-operated stored energy tensioned" indicator switch is automatically provided.

Other Benefits of the NES Type

- The design of the main terminal offers maximum flexibility. The horizontal terminal can be rotated simply at the installation so that it can also be used as a vertical connection. With withdrawable units, additional terminal pieces can even be dispensed with. The cassette of the NES Type offers an integrated flange terminal to connected directly. For this reason, the main terminal pieces for NES Type are not part of the standard scope of delivery. Don't forget to order additionally required terminal pieces if needed.
- Thanks to the separate mounting position, a switching operations counter can now be used also independently of a motor operator.
- Withdrawable unit operation: The unit is actuated with a hand crank supplied as a standard feature and has a secure position in the basic device. This is now possible also with a standard tool (square drive socket 1/4").

External 24 V Supply

- The standard protection functions of the NES Type operate generally independently of an external control voltage supply. The power supply of the electronics unit, for example for overload and short-circuit protection, is implemented via the current transformers integrated in the circuit breaker.
- The universal release unit with display can be fed with a 24 V DC supply if required so that the display function can also be used without a load. An external 24 V DC power supply is needed if communication functions are required.

Configuration

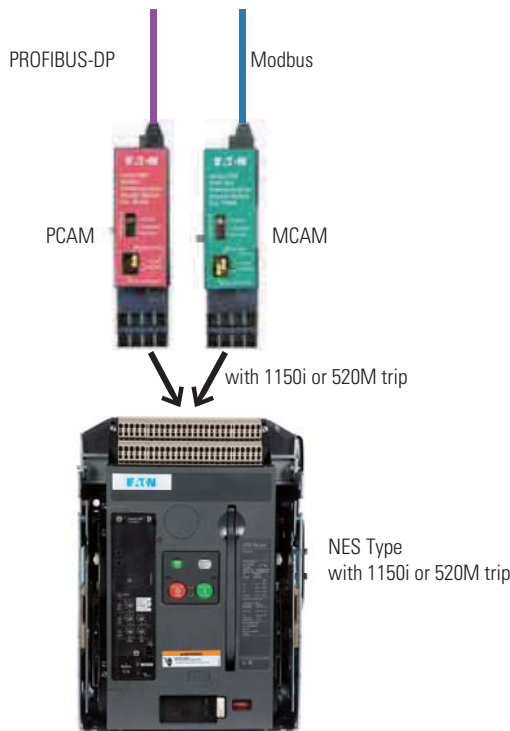

Communication Capability

The communication-capability of the NES Type circuit-breakers open up new possibilities in power distribution. It provides all important operational information and passes this on. This increases system transparency and shortens the response times to states such as overcurrent, phase asymmetry and overvoltage.

A rapid intervention in a process can, for example, prevent downtimes and help to schedule maintenance activities and therefore boost plant availability.

A Modbus interface is offered as an alternative in addition to the Profibus interface.

Selection Criteria for NES Type Circuit-Breakers

Fundamental criteria for the selection of circuit-breakers:

- Max short-circuit current I_{sc} the circuit-breaker point of installation: this value determines the short-circuit breaking capacity or the short-circuit current carrying capacity of the circuit-breaker. It is compared with the L_{cu} , I_{cs} and L_{cw} values of the switch and essentially determines its size (see Technical data).
- Rated operational current I_n should flow through the respective branch circuit: This value must not be greater than the maximum switch rated operational current of the circuit breaker. The rated operational current can be adjusted down using additional rated operational current modules.
- Ambient temperature of the circuitbreaker: This is generally the internal temperature in the control panel. Observe the derating values with increased ambient temperature (see Technical data).
- Circuit-breaker type: fixed mounted or withdrawable units, 3 or 4 pole.
- Minimum short-circuit current, which flows through the switching device: The release must recognize this value as a short-circuit and may react with a trip.
- Protection functions of the This is determined by the selection of the respective overcurrent release.

Components for NES Type Communication

For the NES Type, PROFIBUS-DP or Modbus Modbus RTU are optionally available as fieldbus connections. Communication modules PCAM and MCAM are compact units for direct mounting in the auxiliary terminal strip. On retrofitting, four modular terminals are replaced with one communication module. This is possible for both for fixed and withdrawable units. The terminals provide all data available in the trip block to the fieldbus, including switching state, current, voltage, power, energy, and diagnostic information such as overcurrent, phase asymmetry and overvoltage. Through the bus the motor operator can also be remotely controlled.

Requirements

The communications modules can be used in combination with circuitbreakers ... 520M or ... 1150i ... circuit-breakers.

PROFIBUS-DP Configuration

Communications module PCAM has a 9-pin D-Sub socket for connection to PROFIBUS. The module works as a slave on PROFIBUS-DP; the data is defined through a standardized device master data file, which permits smooth integration of NES Type in a DP line.

- On the PROFIBUS-DP side the module supports automatic baud rate detection; The PROFIBUS-DP bus address is set through the trip unit's display. The maximum cable length is 2.4 km.
- To operate the PCAM, a supply voltage of 24 V DC is required.
- The data connection to the circuit-breaker is implemented internally through a serial high-speed data connection.

Data Access Via PROFIBUS-DP

The data on PROFIBUS-DP are offered according to the profile for low-voltage switchgear (LVSG) of PROFIBUS International (PROFIBUS and PROFINET User Group). Five different data structures with varying numbers of parameters are available through the device master data file. This allows a data filter to be easily implemented, which simplifies integration of the ACB data into the control system.

Modbus Configuration

Communications module MCAM has a plug-in screw terminal for connection to Modbus. The module operates as a Modbus slave.

- Baud rate, data format and address (max. 247) for Modbus are set with the input keys of the trip unit. The maximum cable length is 1.2 km.
- The Modbus must be terminated with a 120Ω terminating resistor.
- To operate the PCAM, a supply voltage of 24 V DC is required.
- The data connection to the circuit-breaker is implemented internally through a serial high-speed data connection.

Data Access Via Modbus

The data is contained in comprehensive data tables. Each data point is available as floating-point (IEEE) or fixed-point value. This variance allows the integration of the NES Type to be adapted to the Modbus architecture. This enables a simple means of implementing a data filter, which facilitates the integration of NES Type data in the control system.

2.2

Low Voltage Air Circuit Breakers IZM Series NES Type

Catalog Number Selection

2

IZM Series NES Type¹

N E S6 08 3 W 52 8 R T R N 4 5 N 4 X

Breaker Frame Size
N = Type NF, 630–1600A,

Standard, Mechanism, Device
E = IEC 60947-2

Fault Current Rating
S4 = 42 kA at 415 Vac IEC
S5 = 50 kA at 415 Vac IEC
S6 = 65 kA at 415 Vac IEC

Frame Rating (Amperes)
07 = 630
08 = 800
10 = 1000
13 = 1250
16 = 1600

Poles, Phasing
3 = Three-pole, ABC
4 = Four-pole, NABC

Mounting Configuration
W = Drawout
B = Fixed mount rear connect, mounting bracket, with secondary terminal row

Trip Unit, Power Supply
SW = Switch—no MCR—42 kA for IEC
22 = 520 LI, no ZSI
52 = 520 LSI, no ZSI
53 = 520 LSI, with ZSI
5G = 520 LSIG, no ZSI
5H = 520 LSIG, with ZSI
M2 = 520M LSI, no ZSI, 24 Vdc
M3 = 520M LSI, with ZSI, 24 Vdc
MA = 520M LSIA, no ZSI, 24 Vdc
MB = 520M LSIA, with ZSI, 24 Vdc
MG = 520M LSIG, no ZSI, 24 Vdc
MH = 520M LSIG, with ZSI, 24 Vdc
R2 = 520M LSI, no ZSI, 24 Vdc, with ARMS
R3 = 520M LSI, with ZSI, 24 Vdc, with ARMS
RA = 520M LSIA, no ZSI, 24 Vdc, with ARMS
RB = 520M LSIA, with ZSI, 24 Vdc, with ARMS
RG = 520M LSIG, no ZSI, 24 Vdc, with ARMS
RH = 520M LSIG, with ZSI, 24 Vdc, with ARMS

Rating Plug(Amperes)
1 = 200 5 = 500 A = 1000
2 = 250 7 = 630 C = 1250
4 = 400 8 = 800 D = 1600
0 = No rating plug, Non-auto switch

Shunt Trip
N = No shunt trip
A = 110–127 Vac/Vdc
R = 208–240 Vac/Vdc
L = 24 Vdc
H = 48 Vdc

Future Use
X = All product

Drawout Breaker Shipping, Fixed Breaker Terminals (Door Frame Kit ships as standard unless noted otherwise)
D = Drawout (or parent) breaker shipping alone, without door frame kit
4 = Drawout breaker in cassette, with shutters, short vertical/horizontal
F = Fixed terminal adapters for rear connect, with mounting feet, short vertical/horizontal

UVR, Second Shunt Trip
N = None
A = 110–125 Vac/Vdc UVR
R = 220–250 Vac/Vdc UVR
L = 24 Vdc UVR
H = 48 Vdc UVR
S = 60 Vdc UVR
G = 32 Vdc UVR
1 = 110–127 Vac/Vdc second shunt trip
2 = 208–240 Vac/Vdc second shunt trip
4 = 24 Vdc second shunt trip
8 = 48 Vdc second shunt trip

Spring Release, Latch Check Switch
N = No spring release, no LCS
E = No spring release, LCS wired external
A = 110–127 Vac/Vdc, no LCS
B = 110–127 Vac/Vdc, spring release LCS
C = 110–127 Vac/Vdc, LCS wired external
R = 208–240 Vac/Vdc, no LCS
S = 208–240 Vac/Vdc, spring release LCS
T = 208–240 Vac/Vdc, LCS wired external
L = 24 Vdc, no LCS
P = 24 Vdc, spring release LCS
Q = 24 Vdc, LCS wired external
H = 48 Vdc, no LCS
J = 48 Vdc, spring release LCS
K = 48 Vdc, LCS wired external

Motor Operator
M = Manually operated
B = 110–125 Vac/dc
T = 208–250 Vac/dc
L = 24 Vdc
H = 48 Vdc

Auxiliary, Switches, Label Language
E = No auxiliary switches, no label (parent)
4 = 4 Form C, English

	Trip Indicator and Bell Alarm	OTS	Secondary Terminal Blocks
N	None	None	Per breaker options ²
5	Interlock trip indicator	2 Form C	Full complement ²

	Padlock Provisions	Key Lock ³ Provisions	Operations Counter
N	No	None	No
A	No	None	Provided
B	Yes (plastic/plastic)	None	No
J	Yes (plastic/plastic)	None	Provided

Note

¹ Exclusionary rules apply. Refer to price list. Confirm all final part numbers with Eaton. Format structure subject to modifications and additions without notice.
² Position 17, ACB (with digitrip) must choose "5", switch-disconnector must choose "N".
³ Order key lock provisions separately in miscellaneous accessories.

Catalog Number Selection

NES Type Frame Cassette

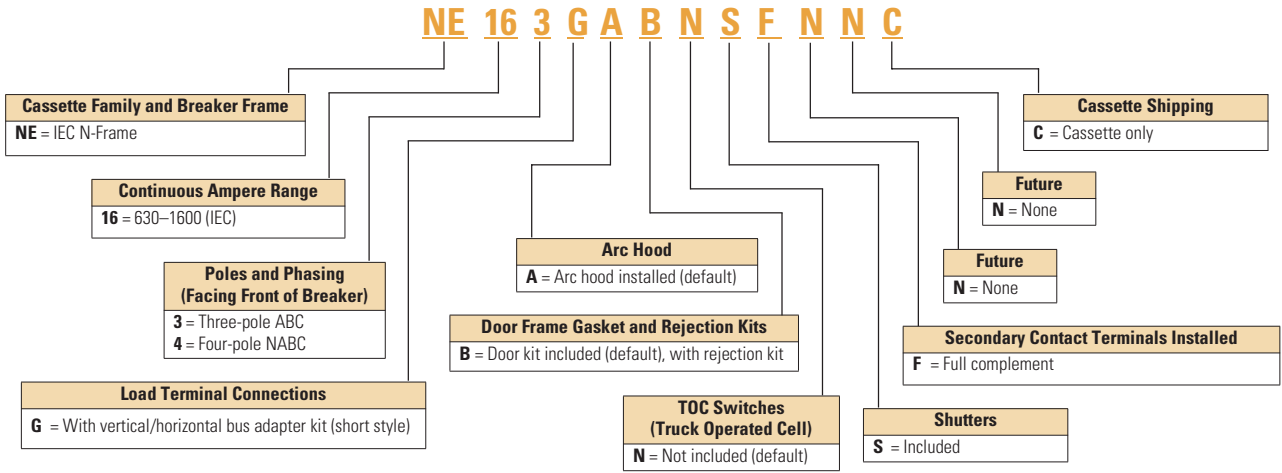

Note

Only supply 2 types cassettes for IEC standard: 3 poles, NE163GABNSFNNC, 4 poles, NE164GABNSFNNC.

2.2

Low Voltage Air Circuit Breakers IZM Series NES Type

Catalog Number Selection

2

IZM Series NES Type — Catalog Position 1–8

Note: Phasing left to right when facing front of breaker (ABC or NABC). Neutral is rated 100% of continuous current.

NES Type



NES Type Frame Basic Device

Switching Capacity I_{cu}/I_{cs} kA (440 Vac)	$I_{cw}/1\text{-sec}$ kA	Continuous Current Rating (40°C)	Three-Pole Configuration	Four-Pole Configuration	Available Sensor Rating Plug (A)
			Catalog Number Position 1–8	Catalog Number Position 1–8	
Drawout-Mounted Configuration					
42/42	42	630	NES4073W	NES4074W	630, 500, 400, 250, 200
		800	NES4083W	NES4084W	800
		1000	NES4103W	NES4104W	1000
		1250	NES4133W	NES4134W	1250
		1600	NES4163W	NES4164W	1600
50/50	42	630	NES5073W	NES5074W	630, 500, 400, 250, 200
		800	NES5083W	NES5084W	800
		1000	NES5103W	NES5104W	1000
		1250	NES5133W	NES5134W	1250
		1600	NES5163W	NES5164W	1600
65/50	42	630	NES6073W	NES6074W	630, 500, 400, 250, 200
		800	NES6083W	NES6084W	800
		1000	NES6103W	NES6104W	1000
		1250	NES6133W	NES6134W	1250
		1600	NES6163W	NES6164W	1600
Fixed-Mounted (with Mounting Feet)					
42/42	42	630	NES4073B	NES4074B	630, 500, 400, 250, 200
		800	NES4083B	NES4084B	800
		1000	NES4103B	NES4104B	1000
		1250	NES4133B	NES4134B	1250
		1600	NES4163B	NES4164B	1600
50/50	42	630	NES5073B	NES5074B	630, 500, 400, 250, 200
		800	NES5083B	NES5084B	800
		1000	NES5103B	NES5104B	1000
		1250	NES5133B	NES5134B	1250
		1600	NES5163B	NES5164B	1600
65/50	42	630	NES6073B	NES6074B	630, 500, 400, 250, 200
		800	NES6083B	NES6084B	800
		1000	NES6103B	NES6104B	1000
		1250	NES6133B	NES6134B	1250
		1600	NES6163B	NES6164B	1600

Catalog Number Selection

Trip Units of NES Type

Digitrip 520 LSI(G)



Digitrip 520M LSI(G)



2

Rated current range		200A-1600A	200A-1600A
RMS value		●	●
Protection and coordination			
Overview			
Options		LSI,LSIG	LSI,LSIG LSIA
Rated current plug (In)		●	●
Over-temperature trip		●	●
Long time delay protection	L		
Long time delay operating value		0.5-1.0X(In)	0.5-1.0X(In)
Long time delay delay-time tr (at 6* Ir)		2-24s	2-24s
Long time delay thermal memory		●	●
Short time delay protection	S		
Short time delay operating value		200-1000%X(Ir)	200-1000%X(Ir)
Short time delay delay-time tsd , I2t at 8* Ir		100-500ms	100-500ms
Short time delay, fixed time		100-500ms	100-500ms
Short time delay zone interlock ZSI		○	○
Non-delayed protection	I		
Non-delayed operating value		200-1200%X(In)	200-1200%X(In)
Non-delayed switch-off function		●	●
Closing release mechanism (MCR)		●	●
Ground fault protection	G		
Ground fault alarming		—	○ ¹⁾
Ground fault operating value		25-100%X(In) ³⁾	25-100%X(In) ³⁾
Ground fault delay time tg at 0.625 Ir , I2t		100-500ms	100-500ms
Ground fault delay time, fixed time lag		100-500ms	100-500ms
Ground fault zone interlock ZSI		○	○
Ground fault thermal memory		●	●
Neutral conductor protection	N		
		●	●
System diagnosis			
Status/Overload LED display		●	●
Trip signal light		●	●
Current at trip point		—	● ²⁾
Long-distance ground fault release/alarming contact		—	● ²⁾
Long-distance overload alarm contact		—	● ²⁾
System monitoring			
Digital display		—	four-digit LCD display
Communication protocol			
		—	Options: Modbus or Profibus
Additional functions			
Testing method ²⁾		Test unit	Test unit
ARMS maintenance system		—	○ ¹⁾

In =rating plug = rated operational current transformer

Ir=Set value of long delay time operating

1) Requires external 24 VDC auxiliary power supply module

2) test units for secondary plugging

3) In combination with ARMS function limited to 1200A

● Standard

○ Optional

2.2 Low Voltage Air Circuit Breakers

IZM Series NES Type

Catalog Number Selection

2

NES Type Miscellaneous Accessories

External Neutral Current Sensor (for Residual Ground)

Catalog Number

NFNCTKIT

Mechanical Interlock Assembly Kits

Catalog Number	Type of Breaker	Interlock Kit Type	Comments
NFMI2F	Fixed	Cable Type 2	Kit also requires 1 Cable Kit
NFMI31F	Fixed	Cable Type 31	Kit also requires 2 Cable Kits
NFMI32F	Fixed	Cable Type 32	Kit also requires 3 Cable Kits
NFMI33F	Fixed	Cable Type 33	Kit also requires 3 Cable Kits
NFMI2D	Drawout	Cable Type 2	Kit also requires 1 Cable Kit
NFMI31D	Drawout	Cable Type 31	Kit also requires 2 Cable Kits
NFMI32D	Drawout	Cable Type 32	Kit also requires 3 Cable Kits
NFMI33D	Drawout	Cable Type 33	Kit also requires 3 Cable Kits

Cable Kits for Mechanical Interlock

Catalog Number	Comments
NRXMIC5	NRX - Cable for Mech. Interlock Kit 1520mm
NRXMIC6	NRX - Cable for Mech. Interlock Kit 1830mm
NRXMIC8	NRX - Cable for Mech. Interlock Kit 2440mm
NRXMIC10	NRX - Cable for Mech. Interlock Kit 3050mm

Cassette Cell Switch Kit

Catalog Number	Comments
NRXCSTK	Cell switch

Key Lock Provision Kit

Catalog Number	Comments
NKIRKKIT	Kirk
NRONISKIT	Ronis
NCASTELLKIT	Castell
NCESKIT	CES

Note: Lock cylinder and key are not supplied.

Time Delay Undervoltage Module

Catalog Number	Comments
70C1316G01	120 VAC
70C1316G02	230 VAC

Communication Module





Catalog Number	Comments	Rated Control voltage Us V	For use with	Notes
MCAM	MODBUS communication module	–	NES Type	Four separately secondary terminal blocks are needed if ordered
PCAM	Profibus communication module	–	NES Type	Four separately secondary terminal blocks are needed if ordered additionally
EASY400-POW 212319	Power supply	–	NES Type	Input voltage: 50/60HZ, 115V/230V, output voltage: 24VD(±3%); output current: 1.25A

Note: Miscellaneous accessories are not in 20 digital part numbers, need to be ordered separately.

Technical Data and Specifications

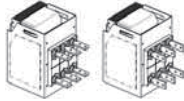
Mounting and Load Connection Configurations

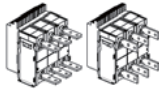
2

Breaker Type	Breaker Mechanism	Standard Bus Connection Provisions	Rear-Connected Horizontal/Vertical Adapter Kit With and Without Cover (Kits Shipped Unassembled)
Drawout Breaker	Stored energy	Finger clusters	—
			
Cassette	—	Rear-connected pre-drilled bus pads	
			
Fixed	Stored energy	Rear-connected pre-drilled bus pads	
			

IEC 60947-2 Ratings

Description	Rating		Rating		Rating	
	Icu	Ics	Icu	Ics	Icu	Ics
Continuous current rating (amperes)	630 and 800		1000 and 1250		1600	
Short-circuit rating (kA)	Icu	Ics	Icu	Ics	Icu	Ics
240/254 Vac	85	50	85	50	85	50
415/435 Vac	65	50	65	50	65	50
690/725 Vac	42	42	42	42	42	42
Short-time withstand = Icw (kA) / 1sec	42	42	42	42	42	42

Note

¹ 35 kAIC short-time withstand at 635V level only. All other voltages 42 kAIC short-time withstand.

2.3

Low Voltage Air Circuit Breakers IZM Series NES Type

Technical Data and Specifications

2 Shunt Trip

Control Voltages	Frequency	Operational Voltage Range 70–110%	Inrush/Continuous Power Consumption (VA)	Opening Time (ms)
24	DC	17–26	500/5	25
48	DC	34–53	530/5	25
110–127	50–60 Hz	77–140	540/5	25
110–125	DC	77–138	540/5	25
208–240	50–60 Hz	146–264	500/5	25
220–250	DC	154–275	515/5	25

UVR

Control Voltages	Frequency	Operational Voltage Range 85–110%	Dropout Volts 35–60%	Inrush/Continuous Power Consumption (VA)	Opening Time (ms)
24	DC	20–26	8–14	500/5	50
32	DC	27–35	11–19	620/5	50
48	DC	41–53	17–29	850/5	50
110–127	50–60 Hz	94–140	44–94	890/5	50
110–125	DC	94–138	44–94	890/5	50
208–240	50–60 Hz	177–264	84–125	910/5	50
220–250	DC	187–275	88–132	910/5	50
380–415	AC	323–457	145–228	960/5	50

Spring Release

Control Voltages	Frequency	Operational Voltage Range 70–110%	Inrush Power Consumption (VA)	Closing Time (ms)
24	DC	17–26	500	25
48	DC	34–53	530	25
110–127	50–60 Hz	77–140	540	25
110–125	DC	77–138	540	25
208–240	50–60 Hz	146–264	500	25
220–250	DC	154–275	515	25

OCT/OTS

Control Voltages	Frequency	Contact Rating (Amperes)
250	50–60 Hz	10
125	DC	0.5
250	DC	0.25

Auxiliary Switch

Control Voltages	Frequency	Contact Rating (Amperes)
250	50–60 Hz	10
125	DC	0.5
250	DC	0.25

Technical Data and Specifications

Breaker Position/Continuity

Breaker Position	Continuity Between Red and Black Lead Pairs	Continuity Between Blue and Black Lead Pairs
Open	NO	45 and 43
	NO	46 and 47
	NO	51 and 49
	NO	52 and 53
Closed	44 and 43	NO
	48 and 47	NO
	50 and 49	NO
	54 and 53	NO

Motor Operator

Control Voltages	Frequency	Operational Voltage Range 85–110%	Running Current (A)	Typical Inrush Current	Power Consumption (VA)	Maximum Charging Time (Sec)
24	DC	20–26	5	500%	150	3
48	DC	41–53	3	500%	150	3
110–127	50–60 Hz	94–140	2	300%	280	3
110–125	DC	94–138	1	500%	150	3
208–240	50–60 Hz	177–264	1	1000%	280	4
220–250	DC	187–275	1	1000%	280	4

Control Voltages and Currents

Control Voltages	24 Vdc	48 Vdc	110–125 Vdc	110–127 Vac	220–250 Vdc	208–240 Vac
Current						
Close current (inrush)	21	11	5	5	2	2
Shunt trip current (ST)—(inrush/continuous)	21 / .2	11 / .1	5 / .04	5 / .04	2 / .02	2 / .02
Charge motor current—(inrush/continuous)	TBD	TBD	5 / 1	6 / 2	10 / 1	10 / 1
Operating Voltage Rating						
Close	17–26	34–53	77–138	77–140	154–275	146–264
Trip	17–26	34–53	77–138	77–140	154–275	146–264
Charge	20–26	41–53	94–138	94–140	187–275	177–264

Dimensions

Approximate Dimensions in Inches (mm)

NES Type Three-Pole Drawout with Cassette

Height	Width	Depth	Lbs (kg)
14.18 (360.2)	10.02 (254.5)	10.68 (271.3)	85.00 (38.59)

Fixed Circuit Breaker and Drawout with Cassette

Breaker Type	Height	Width	Depth	Lbs (kg)
Fixed				
Three-pole	13.18 (334.8)	8.25 (209.6)	7.15 (181.6)	33.58 (15.23)
Four-pole	13.18 (334.8)	11.00 (279.4)	7.15 (181.6)	44.40 (20.14)
Drawout with Cassette				
Three-pole	14.18 (360.2)	10.02 (254.5)	10.69 (271.5)	85.20 (38.65)
Four-pole	14.18 (360.2)	12.69 (322.3)	10.69 (271.5)	104.00 (47.17)

2.4 Low Voltage Air Circuit Breakers

IZM Series NES Type

Dimensions

2 NES Type Fixed Mounted

NES...F

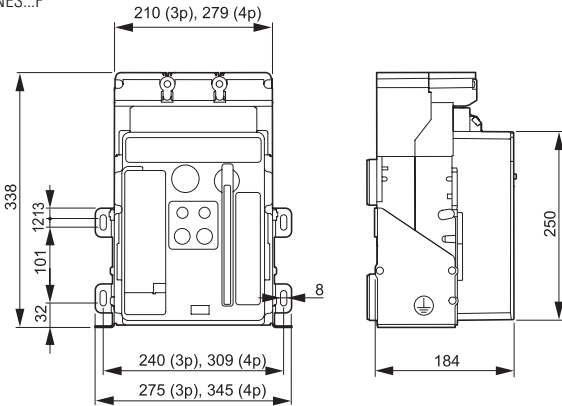

NES Type Drawout

NES...W

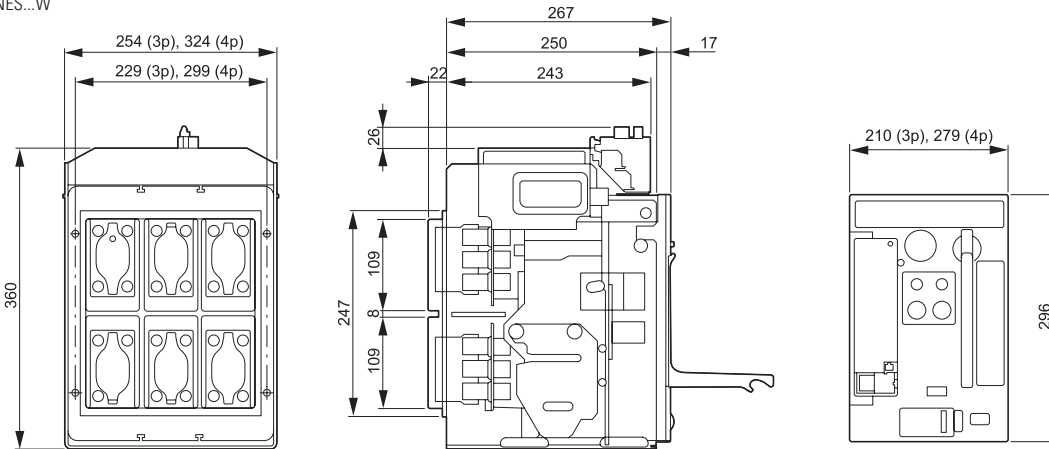

Current Transformer of Neutral Conductor of NES Type

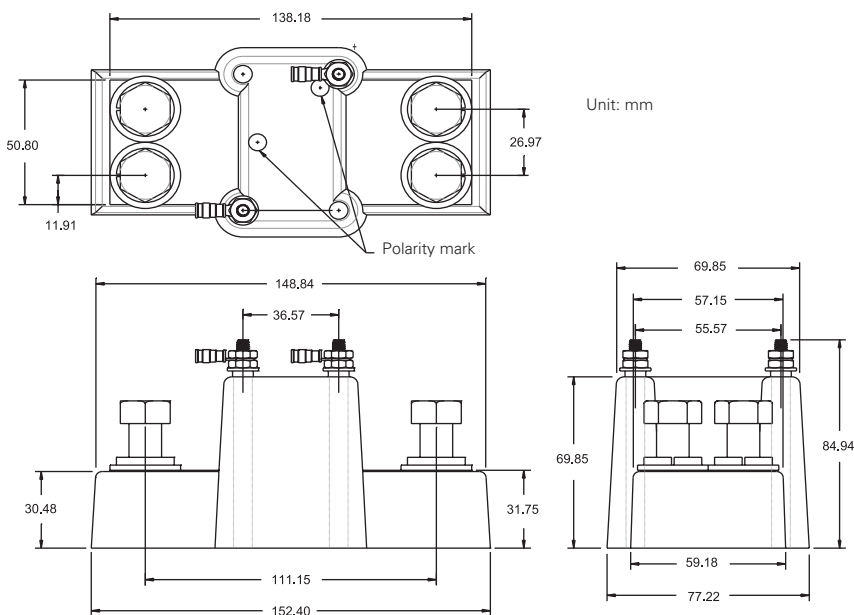

Wiring Diagrams

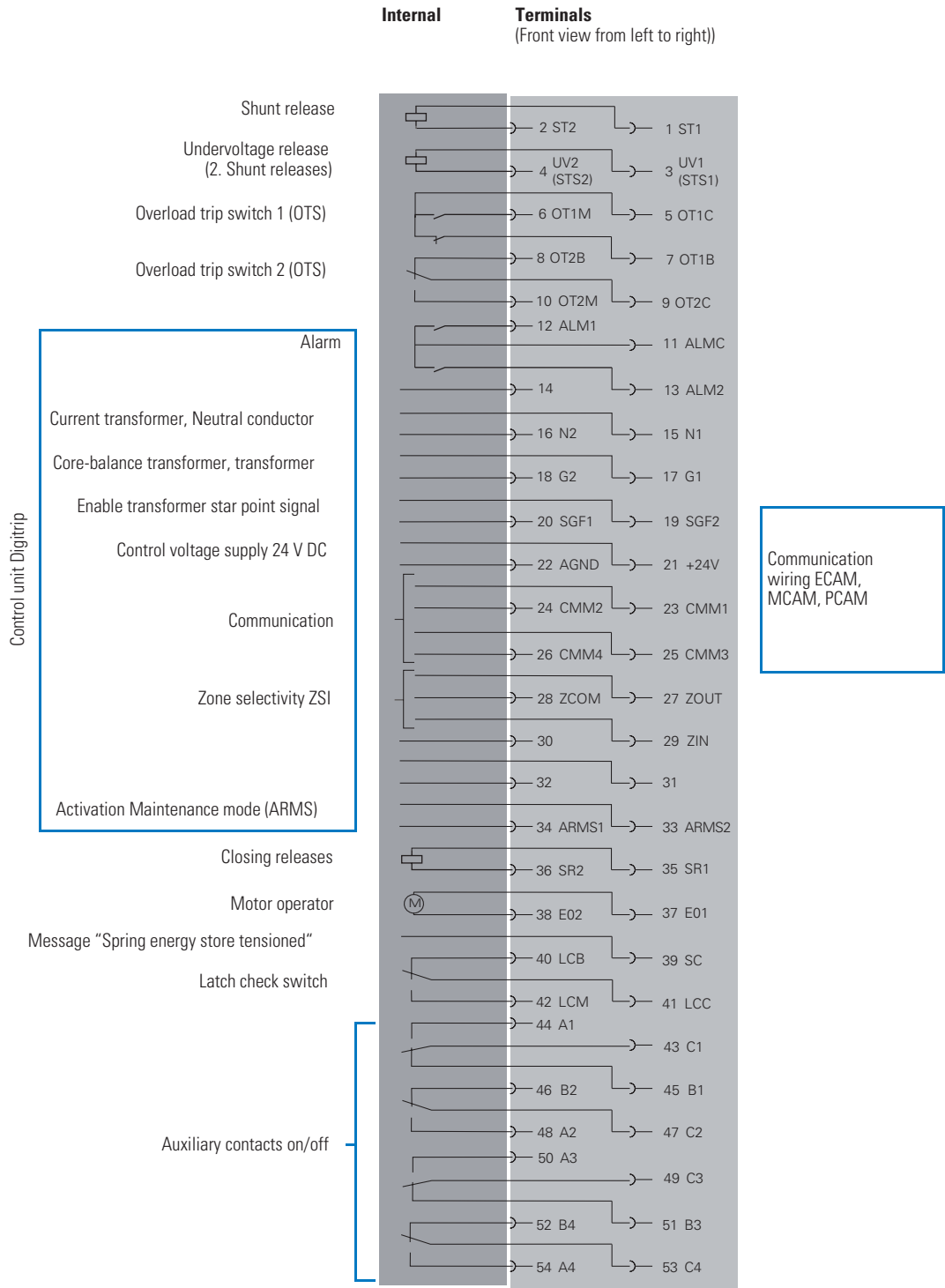

Low Voltage Air Circuit Breakers

IZM Series MWI Type

MWI Type



3

3.1 Standards and Certifications	
IZM Series MWI Type.....	17
3.2 Catalog Number Selection	
IZM Series MWI Type.....	20
3.3 Technical Data and Specifications	
IZM Series MWI Type.....	27
3.4 Dimensions	
IZM Series MWI Type.....	29
3.5 Wiring Diagrams	
IZM Series MWI Type.....	32

IZM Series MWI Type

Product Description

MWI Type Air Circuit Breakers are designed to enable global power distribution solutions in IEC switchboards and other custom enclosures.

- MWI Type Air Circuit Breakers have interrupting ratings up to 100 kA at 690 Vac with continuous current ratings up to 6300A
- MWI Type Air Circuit Breaker continuous current frames are 100% rated. No thermal de-rating is required when applying the breaker in the low voltage systems enclosure at ambient temperatures of 104°F (40°C)

Standards and Certifications

IEC Test Certifications

MWI Type Air Circuit Breakers meet or exceed the applicable IEC standards, including:

- EN/IEC 60947-2

Comprehensive Enclosure Solutions

MWI Type Air Circuit Breakers have proven performance in IEC switchboards and custom enclosures manufactured by Eaton and Low Voltage Systems Builders (OEMs) to the following standards:

- EN/IEC 60947-1
- EN/IEC 60439-1

Approvals and Marks

MWI Type Air Circuit Breakers carry the following approvals and approval marks:

- CE
- American Bureau of Shipping (ABS)
- Det Norske Veritas (DNV)
- Lloyds of London
- South African Bureau of Standards (SABS)
- For a complete and comprehensive listing of all low voltage power breakers, please visit www.eaton.com/SEAsia

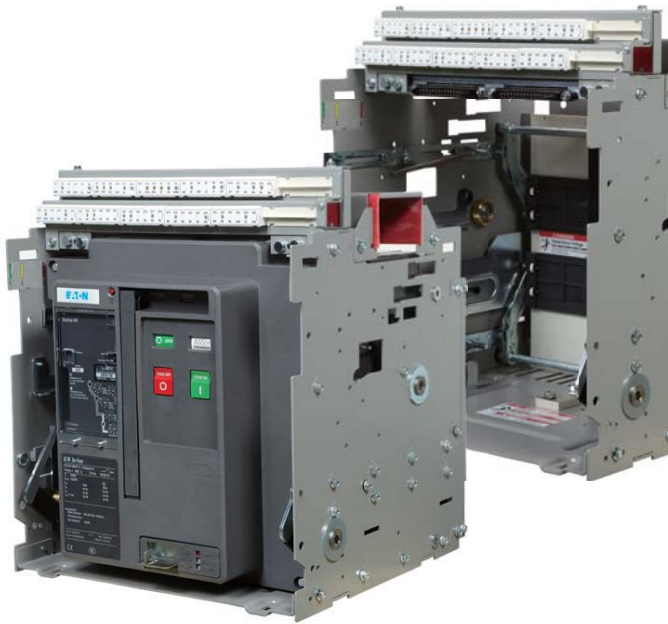

MWI Type : Robust Safety

Eaton's MWI Type , circuit-breakers offer a proven and complete range of air circuit-breakers up to 6300 A. Four sizes enable the ideal circuit-breaker to be selected economically for any project. In this way, only the module width increases with the required rated operational current, enabling the most compact and economical size to be selected. The particularly rugged circuit-breakers are already in use 100,000 times in harsh industrial environments worldwide. Large material thicknesses and a high short-time withstand current are its characteristic features.

Applications

The circuit-breakers can be used in four main application areas depending on the type of equipment to be protected:

- System protection,
- Motor protection,
- Transformer protection,
- Generator protection.

These key applications make different demands on the switches, which are met with a range of trip units.

Switches with Closing Release

They are particularly suitable for synchronization tasks.

Coupler Switches

Beside the MWI Type . circuit-breakers, MWI Type switch-disconnectors are available. These are used, for example, as coupler switches between different power supplies.

Modular Design

Because components are installed from the front, retrofitting accessories is especially quick and easy. This allows flexible response to changing requirements within the system.

Standard Scope of Delivery as Usual

- The standard mounting is on a horizontal mounting plate or on horizontal traverses in the switching cabinet.
- With four-pole devices, the neutral conductor is arranged on the left (front view).
- The neutral conductor can be loaded 100% like the phase conductors.
- The circuit-breakers are provided with a standard mechanical reclosing lockout. After an overload trip, the fault is usually examined first of all. After the fault is identified and rectified, the mechanical reclosing lockout is reset by pressing the red mechanical trip indicator on the front of the circuit-breaker.
- An "Automatic Reset" can be ordered as an option. This enables the circuit-breaker to be restored to operation immediately at any time after the spring-operated stored energy mechanism is retensioned. In these applications compulsory fault analysis is intentionally avoided.
- If a cassette is ordered without the basic device, this is already fitted with the maximum number of control cable terminals.
- A coding mechanism between the basic device and the cassette prevents impermissible combinations ("Rejection Interlock").

Expansion of Standard equipment Supplied for MWI Type

Some order types from the past can no longer be found since the following options are now already part of the standard scope of delivery:

- The door escutcheon is now always included in the scope of delivery. With withdrawable designs this is supplied with the cassette (withdrawable unit).
- On withdrawable units the circuitbreaker can be pulled out to inspect the arc chutes. With fixed units, it is recommended that sufficient space is provided above the circuitbreaker to enable inspection. An additional cover is not required.
- On each circuit-breaker the integrated Digitrip electronic release is factory fitted with a sealable protective cover.
- If a motor operator is ordered, the "Spring-operated stored energy mechanism tensioned" indicator switch is automatically provided.

Other Benefits of the MWI Type

- There are three main variants of overcurrent release units, 520, 520M, 1150 Series. On Digitrip 1150) , the power measurement is already an integral part of the electronic release.
- The voltage tap-off for power measurement is integrated in the device so that an additional external voltage transformer is unnecessary. This solution saves costs, space and installation effort.
- Certain applications require the use of an interface to the external control voltage supply (see below). A new feature is that the electronic release can be prepared for an external control voltage supply of 120 V AC or 240 V AC (order option).
- A switching operations counter can now be used thanks to the separate mounting position, also independently of a motor operator.
- Withdrawable unit operation: The unit is actuated with a hand crank supplied. This is now possible also with a standard tool (square drive socket 3/8").
- The entire rated operational current range from 800 A to 6300 A can be covered with two sizes.
- Sizes ACB 6300A are produced in simple terms by doubling ACB 3200A. This consequently provides on the ACB 6300A two terminals for each phase on the incoming side and on the outgoing side. This facilitates the thermal design of the switchboard and in some switchboard systems simplifies production and reduces the number of busbar adapter variants.
- The phase sequence for the ACB 6300A is as follows: (NN)AABCC.
- The ACB 6300A is now offered with horizontal connection as standard, thus considerably simplifying the busbar connection for most switchboard systems.

External Control Voltage Supply

- The standard protection functions of the MWI Type , operate generally independently of an external control voltage supply. The power supply of the electronics unit, for example for overload and short-circuit protection, is implemented via the current transformers integrated in the circuit-breaker.
- The universal release unit with display can be fed with a 24 V DC/48 V DC supply or a 120 V AC or 240 V AC supply if required so that the display function can also be used without a load. An external power supply is needed if communication functions are required.
- The 1150i prelease unit should always be operated with an external power supply as it is normally selected due to its extensive control voltage dependent functions.

Communication Capability

The communication-capability of the MWI Type circuit-breakers enable them to open up new possibilities in power distribution. They can thus provide and transmit all important operational information. This increases system transparency and shortens the response times to states such as overcurrent, phase asymmetry and overvoltage. A rapid intervention in a process can, for example, prevent downtimes and help to schedule maintenance activities and therefore boost plant availability. A Modbus interface is offered as an alternative in addition to the Profibus interface.

Selection Criteria for MWI Type Circuit-Breakers

Fundamental criteria for the selection of circuit-breakers:

- Max short-circuit current $I_{k,max}$ at the circuit-breaker's point of installation: this value determines the short-circuit breaking capacity or the short-circuit current carrying capacity of the circuit-breaker. It is compared to the I_{cu}, I_{cs} and I_{cw} values of the circuit-breaker and determines essentially its size (see Technical data).
- Rated operational current I_n , which should flow through the respective branch circuit: This value must not be greater than the maximum switch rated operational current of the circuit-breaker. The rated operational current can be adjusted down using additional rated operational current modules.
- Ambient temperature of the circuit-breaker: This is generally the internal temperature in the control panel. Observe the derating values with increased ambient temperature (see Technical data).
- Circuit-breaker type: fixed mounted or withdrawable units, 3 or 4 pole.
- Minimum short-circuit current, which flows through the switching device: The release must recognize this value as a shortcircuit and may react with a trip.
- Protection functions of the circuitbreaker: This is determined by the selection of the respective overcurrent release.

3.1 Low Voltage Air Circuit Breakers

IZM Series MWI Type

Components for MWI Type Communication

The MWI Type series devices can be connected to a PROFIBUS-DP or Modbus RTU field bus. Interfaces PMINT and MMINT are compact devices for mounting on top-hat rails, i.e. independently of the switch. They output all information available in the trip unit to the fieldbus, including switch status, current, voltage, power, and energy, as well as diagnostic information such as overcurrent, phase asymmetry and overvoltage. The fieldbus also facilitates actuation of the motor operator and therefore its remote operation.

Requirements

The communications modules can be used in combination with MWI Type...520MC or 1150i... circuit-breakers.

PROFIBUS-DP configuration

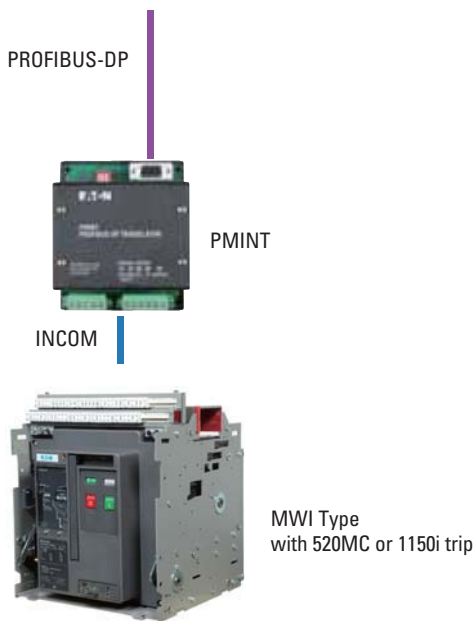

Communications module PMINT has a 9-pin D-Sub socket for connection to PROFIBUS. The module works as a slave on PROFIBUS-DP; the data is defined through a standardized device master data file, which permits smooth integration of the IZM in a DP line.

PROFIBUS

- On the PROFIBUS-DP side the module supports automatic baud rate detection; the PROFIBUS-DP bus address is set through the trip unit's display. The maximum cable length is 2.4 km.
- To operate the PMINT, a supply voltage of 24-125VDC or 100-240VAC(50/60Hz) is required.

INCOM

- The data connection to the circuit-breaker is implemented through a serial INCOM data connection. A shielded, twisted-pair data cable (recommended are Belden 9463 or 3073F) can be used.
- The INCOM bus must be terminated with a 100 Ω terminating resistor, connected between the two cable strands at the circuit-breaker end.
- The maximum cable length is 3 km.

Data access via PROFIBUS-DP

The data on PROFIBUS-DP are offered according to the profile for low-voltage switchgear (LVSG) of PROFIBUS International (PROFIBUS and PROFINET User Group). Five different data structures with varying numbers of parameters are available through the device master data file. This allows a data filter to be easily implemented, which simplifies integration of the IZM data into the control system.

Modbus configuration

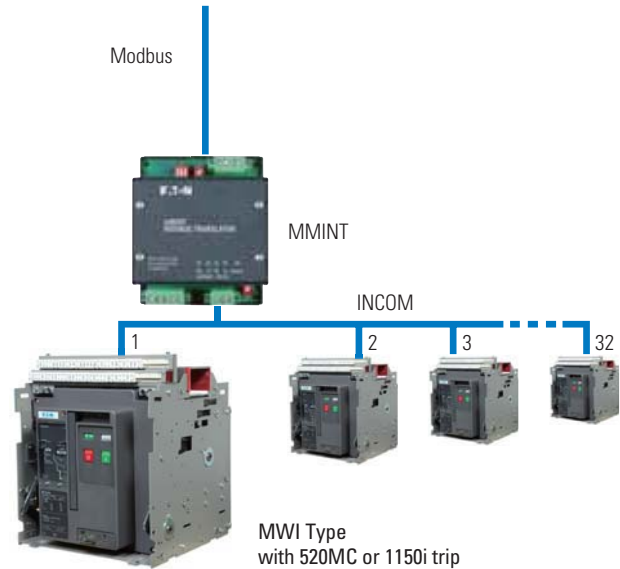

Communications module MMINT has a plug-in screw terminal for connection to Modbus. The module operates as a Modbus slave. The interface to the circuit-breaker can be operated as a bus, so that up to 32 MWI Type units can be connected to an MMINT. This makes the use of the IZM with the Modbus architecture specially efficient.

Modbus

- The baud rate for Modbus communications is selectable with coding switches on the MMINT; the bus address (up to 247) is set through the display of the trip unit. The maximum cable length is 1.2 km.
- The Modbus must be terminated with a 120 Ω terminating resistor. If the MMINT is the last device in the network, a built-in terminating resistor can be activated there with a coding switch.
- To operate the MMINT, a supply voltage of 24-125VDC or 120VAC is required.

INCOM

- The data connection to the circuit-breaker is implemented through a serial INCOM bus connection. A shielded, twisted-pair data cable (recommended are Belden 9463 or 3073F) can be used.
- The INCOM bus must be terminated with a 100 Ω terminating resistor, connected between the two cable strands at the circuit-breaker end.
- The maximum cable length is 3 km.

Data access via Modbus

The data for each circuit-breaker connected to the INCOM bus is contained in comprehensive data tables. Each data point is available as floating-point (IEEE) or fixed-point value. This variance allows the integration of the IZM to be adapted to the Modbus architecture. This allows a data filter to be easily implemented, which simplifies integration of the IZM data into the control system.

Catalog Number Selection

MWI Type Breaker Product Family¹

MW I 8 12 4 L E A - 12 MT R P R N 4 L N N N W X

3

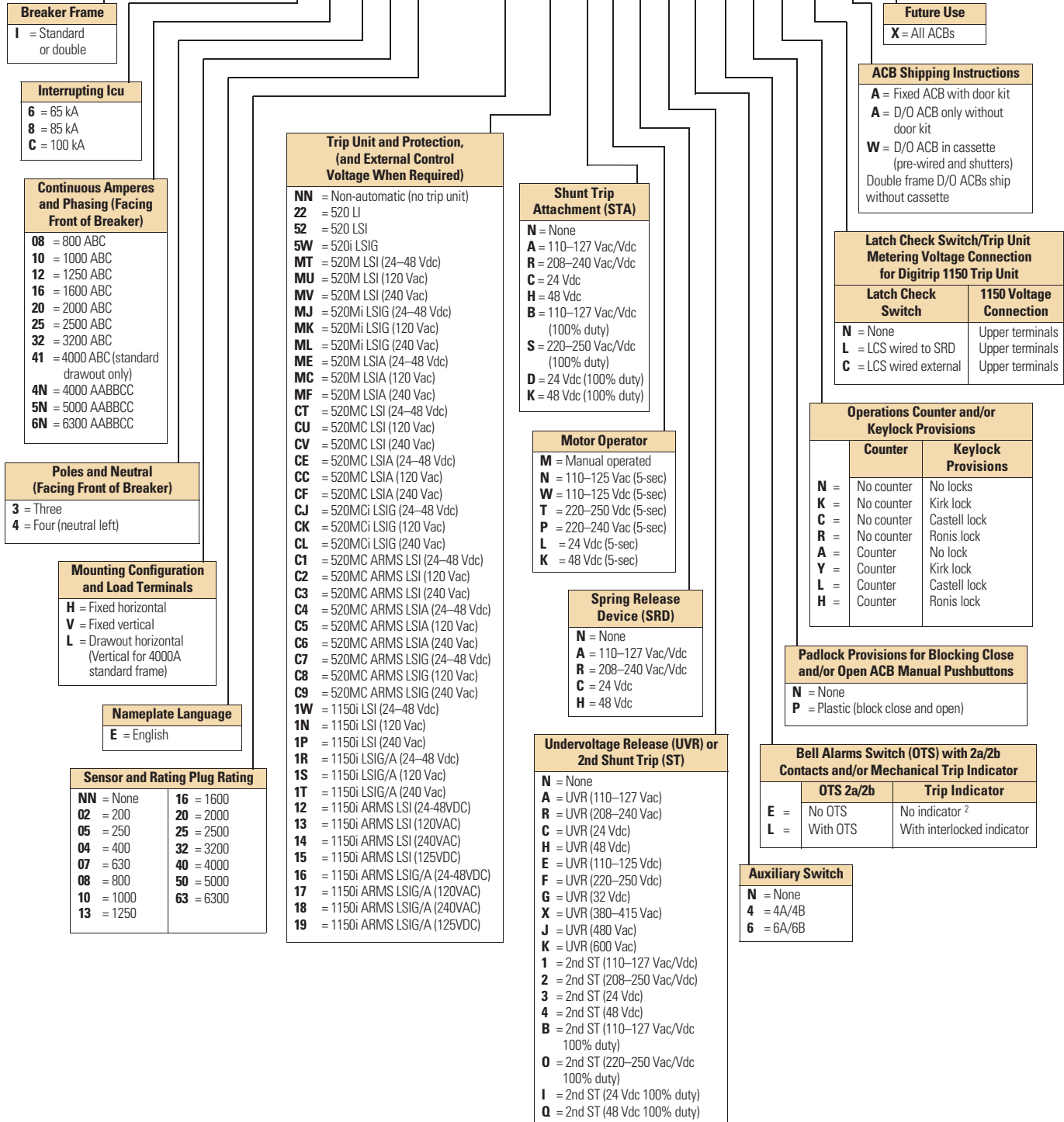

Note

¹ Exclusionary rules apply. Refer to price list. Confirm all final part numbers with Eaton. Format structure subject to modifications and additions without notice.
² Position 20, ACB (with digitrip) must choose "L", switch-disconnector must choose "E".

3.2 Low Voltage Air Circuit Breakers

IZM Series MWI Type

Catalog Number Selection

Cassette MWI Type Breaker Product Family¹

3

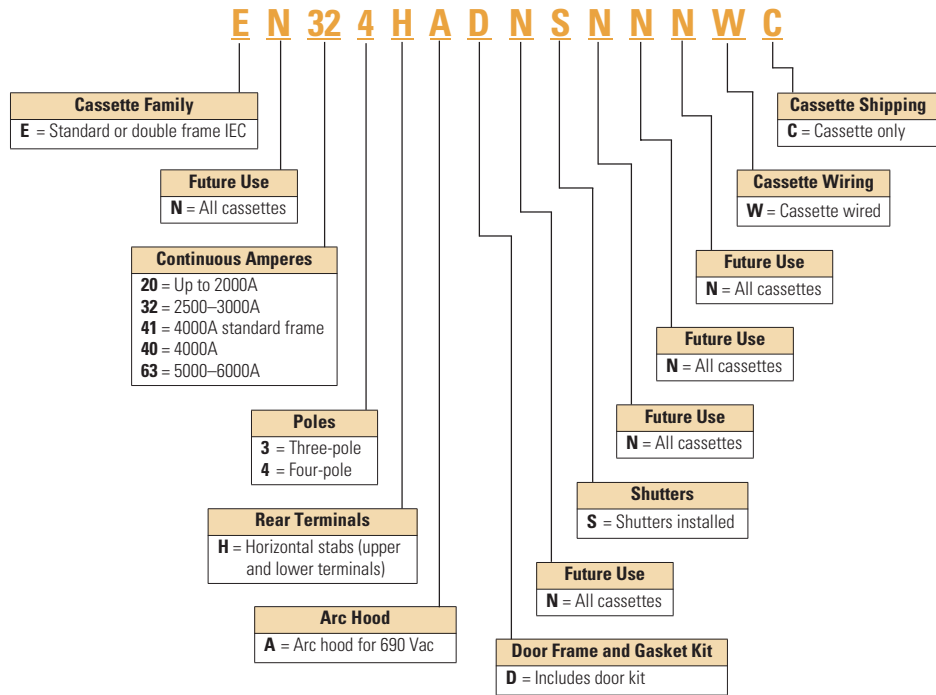

Note

¹ Exclusionary rules apply. Refer to price list. Confirm all final part numbers with Eaton. Format structure subject to modifications and additions without notice.



Catalog Number Selection

MWI Type ACB—Drawout Circuit Breaker

Interrupting Rating (kA) at 440V I _{cu} /I _{cs} ²	I _{cw} Withstand Rating (kA) 1-Sec/3-Sec	Continuous Current Rating Amps at 40°C ¹	Magnum ACB Frame Type	3-Pole Catalog Number Positions 1-10	3-Pole ³ Phasing (Left to Right)	4-Pole Catalog Number Positions 1-10	4-Pole ³ Phasing (Left to Right)
Standard Frame Drawout Circuit Breaker⁵							
65/65	65/--	800	Standard	MWI6083LEA	ABC	MWI6084LEA	NABC
65/65	65/--	1000	Standard	MWI6103LEA	ABC	MWI6104LEA	NABC
65/65	65/--	1250	Standard	MWI6123LEA	ABC	MWI6124LEA	NABC
65/65	65/--	1600	Standard	MWI6163LEA	ABC	MWI6164LEA	NABC
65/65	65/50	2000	Standard	MWI6203LEA	ABC	MWI6204LEA	NABC
65/65	65/50	2500	Standard	MWI6253LEA	ABC	MWI6254LEA	NABC
65/65	65/50	3200	Standard	MWI6323LEA	ABC	MWI6324LEA	NABC
65/65	65/50	4000	Standard	MWI6413LEA	ABC	MWI6414LEA	NABC
85/85	85/65	800	Standard	MWI8083LEA	ABC	MWI8084LEA	NABC
85/85	85/65	1000	Standard	MWI8103LEA	ABC	MWI8104LEA	NABC
85/85	85/65	1250	Standard	MWI8123LEA	ABC	MWI8124LEA	NABC
85/85	85/65	1600	Standard	MWI8163LEA	ABC	MWI8164LEA	NABC
85/85	85/65	2000	Standard	MWI8203LEA	ABC	MWI8204LEA	NABC
85/85	85/65	2500	Standard	MWI8253LEA	ABC	MWI8254LEA	NABC
85/85	85/65	3200	Standard	MWI8323LEA	ABC	MWI8324LEA	NABC
85/85	85/65	4000	Standard	MWI8413LEA	ABC	MWI8414LEA	NABC
100/100 ⁴	85/65	800	Standard	MWIC083LEA	ABC	MWIC084LEA	NABC
100/100 ⁴	85/65	1000	Standard	MWIC103LEA	ABC	MWIC104LEA	NABC
100/100 ⁴	85/65	1250	Standard	MWIC123LEA	ABC	MWIC124LEA	NABC
100/100 ⁴	85/65	1600	Standard	MWIC163LEA	ABC	MWIC164LEA	NABC
100/100 ⁴	85/65	2000	Standard	MWIC203LEA	ABC	MWIC204LEA	NABC
100/100 ⁴	85/65	2500	Standard	MWIC253LEA	ABC	MWIC254LEA	NABC
100/100 ⁴	85/65	3200	Standard	MWIC323LEA	ABC	MWIC324LEA	NABC
105/105 ⁴	85/65	4000	Standard	MWIC413LEA	ABC	MWIC414LEA	NABC
Double Frame Drawout Circuit Breaker⁵							
85/85	85/65	4000	Double	MWI84N3LEA	AABBCC	MWI84N4LEA	NNAABBCC
85/85	85/65	5000	Double	MWI85N3LEA	AABBCC	MWI85N4LEA	NNAABBCC
85/85	85/65	6300	Double	MWI86N3LEA	AABBCC	MWI86N4LEA	NNAABBCC
100/100	100/85	4000	Double	MWIC4N3LEA	AABBCC	MWIC4N4LEA	NNAABBCC
100/100	100/85	5000	Double	MWIC5N3LEA	AABBCC	MWIC5N4LEA	NNAABBCC
100/100	100/85	6300	Double	MWIC6N3LEA	AABBCC	MWIC6N4LEA	NNAABBCC

Notes

- MWI air circuit breakers are 100% thermal rated (no de-rating necessary when properly applied in a specified enclosure).
- Interrupting ratings shown are also applicable at 380V/415V/440V/500V/690V unless otherwise indicated.
- Phasing left to right when facing front of breaker. Neutral is rated 100% of continuous current.
- I_{cu} and I_{cs} are 100kA at 440Vac and 85kA at 690Vac (except I_{cu} and I_{cs} of MWIC413LEA and MWIC414LEA are 105kA at 440Vac and 85kA at 690Vac).
- MWI ACBs carry an IT rating at 440Vac per EN 60947-2 Annex H. Contact Cutler-Hammer for 690Vac IT applications.

3.2 Low Voltage Air Circuit Breakers

IzM Series MWI Type

Catalog Number Selection

MWI Type ACB—Fixed Circuit Breaker

3

Interrupting Rating (kA) at 440V Icu/Ics ²	Icw Withstand Rating (kA) 1-Sec/3-Sec	Continuous Current Rating Amps at 40°C ¹	Magnum ACB Frame Type	3-Pole Catalog Number Positions 1-10 ³	3-Pole ⁴ Phasing (Left to Right)	4-Pole Catalog Number Positions 1-10 ³	4-Pole ⁴ Phasing (Left to Right)
Standard Frame Fixed Circuit Breaker ⁶							
65/65	65/--	800	Standard	MWI6083HEA	ABC	MWI6084HEA	NABC
65/65	65/--	1000	Standard	MWI6103HEA	ABC	MWI6104HEA	NABC
65/65	65/--	1250	Standard	MWI6123HEA	ABC	MWI6124HEA	NABC
65/65	65/--	1600	Standard	MWI6163HEA	ABC	MWI6164HEA	NABC
65/65	65/50	2000	Standard	MWI6203HEA	ABC	MWI6204HEA	NABC
65/65	65/50	2500	Standard	MWI6253HEA	ABC	MWI6254HEA	NABC
65/65	65/50	3200	Standard	MWI6323HEA	ABC	MWI6324HEA	NABC
85/85	85/65	800	Standard	MWI8083HEA	ABC	MWI8084HEA	NABC
85/85	85/65	1000	Standard	MWI8103HEA	ABC	MWI8104HEA	NABC
85/85	85/65	1250	Standard	MWI8123HEA	ABC	MWI8124HEA	NABC
85/85	85/65	1600	Standard	MWI8163HEA	ABC	MWI8164HEA	NABC
85/85	85/65	2000	Standard	MWI8203HEA	ABC	MWI8204HEA	NABC
85/85	85/65	2500	Standard	MWI8253HEA	ABC	MWI8254HEA	NABC
85/85	85/65	3200	Standard	MWI8323HEA	ABC	MWI8324HEA	NABC
100/100 ⁵	85/65	800	Standard	MWIC083HEA	ABC	MWIC084HEA	NABC
100/100 ⁵	85/65	1000	Standard	MWIC103HEA	ABC	MWIC104HEA	NABC
100/100 ⁵	85/65	1250	Standard	MWIC123HEA	ABC	MWIC124HEA	NABC
100/100 ⁵	85/65	1600	Standard	MWIC163HEA	ABC	MWIC164HEA	NABC
100/100 ⁵	85/65	2000	Standard	MWIC203HEA	ABC	MWIC204HEA	NABC
100/100 ⁵	85/65	2500	Standard	MWIC253HEA	ABC	MWIC254HEA	NABC
100/100 ⁵	85/65	3200	Standard	MWIC323HEA	ABC	MWIC324HEA	NABC
Double Frame Fixed Circuit Breaker ⁶							
85/85	85/65	4000	Double	MWI84N3HEA	AABBCC	MWI84N4HEA	NNAABBCC
85/85	85/65	5000	Double	MWI85N3HEA	AABBCC	MWI85N4HEA	NNAABBCC
85/85	85/65	6300	Double	MWI86N3HEA	AABBCC	MWI86N4HEA	NNAABBCC
100/100	100/85	4000	Double	MWIC4N3HEA	AABBCC	MWIC4N4HEA	NNAABBCC
100/100	100/85	5000	Double	MWIC5N3HEA	AABBCC	MWIC5N4HEA	NNAABBCC
100/100	100/85	6300	Double	MWIC6N3HEA	AABBCC	MWIC6N4HEA	NNAABBCC

Notes

- ¹ MWI air circuit breakers are 100% thermal rated (no de-rating necessary when properly applied in a specified enclosure).
- ² Interrupting ratings shown are also applicable at 380V/415V/440V/500V/690V unless otherwise indicated.
- ³ Fixed breakers have (H) horizontal terminals. Vertical adapters (V) are priced separately.
- ⁴ Phasing Left to Right when facing front of circuit breaker - Neutral rated 100% of continuous current.
- ⁵ Icu and Ics are 100kA at 440Vac and 85kA at 690Vac.
- ⁶ MWI ACBs carry an IT rating at 440Vac per EN 60947-2 Annex H. Contact Cutler-Hammer for 690Vac IT applications.
- ⁷ MWI standard size fixed ACB doesn't have 4000A.

Catalog Number Selection

Digitrip Trip Units for MWI Type ACB



3

Trip Unit Type		Digitrip 520 <i>i</i>	Digitrip 520M <i>i</i>	Digitrip 520MC <i>i</i>	Digitrip 1150 <i>i</i> + ¹
Ampere range		200–6300A	200–6300A	200–6300A	200–6300A
Interrupting rating at 690V		40–100 kA	40–100 kA	40–100 kA	40–100 kA
rms sensing		Yes	Yes	Yes	Yes
Protection and Coordination					
Protection	Ordering options	LI, LSI, LSIG	LSI, LSIG, LSIA	LSI, LSIG, LSIA	LSI, LSIG, LSIA
	Fixed rating plug (I_n)	Yes	Yes	Yes	Yes
	Overtemperature trip	Yes	Yes	Yes	Yes
Long delay protection (L)	Long delay setting	0.4–1.0 x (I_n)	0.4–1.0 x (I_n)	0.4–1.0 x (I_n)	0.4–1.0 x (I_n)
	Long delay time I^2t at $6 \times I_r$	2–24 sec	2–24 sec	2–24 sec	2–24 sec
	Long delay time I^4t	No	No	No	1–5 sec
	IEC Type A, B, C curves	No	No	No	Yes
	Long delay thermal memory	Yes	Yes	Yes	Yes
	High load alarm	No	No	No	0.7–1.0 x I_r
Short delay protection (S)	Short delay pickup	200–1000% x (I_r) & M1	200–1000% x (I_r) & M1	200–1000% x (I_r) & M1	150–1000% x (I_r) & M1
	Short delay time I^2t at $8 \times I_r$	100–500 ms	100–500 ms	100–500 ms	100–500 ms
	Short delay time flat	100–500 ms	100–500 ms	100–500 ms	100–500 ms
	Short delay time ZSI	Yes	Yes	Yes	Yes
Instantaneous protection (I)	Instantaneous pickup	200–1000% x (I_n) & M1	200–1000% x (I_n) & M1	200–1000% x (I_n) & M1	200–1000% x (I_n) & M1
	Making current release	Yes	Yes	Yes	Yes
	Off position	Yes	Yes	Yes	Yes
Earth fault protection (G)	Earth fault alarm	No	Yes	Yes	Yes
	Earth fault pickup	25–100% x (I_n)	25–100% x (I_n)	25–100% x (I_n)	10–100% x (I_n)
	Earth fault delay I^2t at $0.625 \times I_n$	100–500 ms	100–500 ms	100–500 ms	100–500 ms
	Earth fault delay flat	100–500 ms	100–500 ms	100–500 ms	100–500 ms
	Earth fault ZSI	Yes	Yes	Yes	Yes
Earth fault memory	Yes	Yes	Yes	Yes	
Disable ground fault protection		No	No	No	Yes
Neutral protection (N)		Model LSI	Model LSI	Model LSI	Model LSI
System Diagnostics					
Cause of trip LEDs		Yes	Yes	Yes	Yes
Magnitude of trip information		No	No	No	Yes
Remote signal contacts		No	Yes	Yes	Yes
Programmable contacts		No	No	No	2

Notes

¹ Over and undervoltage alarm or trip, over and underfrequency alarm or trip, voltage unbalance alarm or trip, reverse power trip and phase rotation alarm are included.

I_n = Rating plug rating.

I_r = LDPU setting.

i Trip units are only used on IEC breakers with earth fault.

3.2 Low Voltage Air Circuit Breakers

IZM Series MWI Type

Catalog Number Selection

Digitrip Trip Units for MWI Type ACB, continued

3



Trip Unit Type	Digitrip 520 <i>i</i>	Digitrip 520M <i>i</i>	Digitrip 520MC <i>i</i>	Digitrip 1150 <i>i</i> ¹
System Monitoring				
Digital display	No	4-Character LCD	4-Character LCD	24-Character LED
Current (%) full scale sensor	No	Yes +/- 2%	Yes +/- 2%	Yes +/- 1%
Voltage (%) L to L	No	No	No	Yes +/- 1%
Power and energy (%)	No	No	No	Yes +/- 2%
Apparent power kVA and demand	No	No	No	Yes
Reactive power kVAR	No	No	No	Yes
Power factor	No	No	No	Yes
Crest factor	No	No	No	Yes
Power quality—harmonics	No	No	No	Yes
% THD	No	No	No	Yes
System Communications				
Type	—	—	INCOM/PowerNet/Modbus ² / PROFIBUS ²	INCOM/PowerNet/TripLink/Modbus ² /PROFIBUS ²
Power supply in breaker	N/A	Optional	Standard	Standard
Additional Features				
Trip log (three events)	No	No	No	Yes
Electronic operations counter	No	No	No	Yes
Testing method ³	Test set	Test set	Test set	Integral and test set
Waveform capture	No	No	No	Yes
ARMs (Arcflash Reduction Maintenance System Mode)	No	No	Yes	Yes ⁴
Breaker health monitor	No	No	No	Yes
Programmable relay functions	No	No	No	Yes ¹

Notes

- ¹ Over and undervoltage alarm or trip, over and underfrequency alarm or trip, voltage unbalance alarm or trip, reverse power trip and phase rotation alarm are included.
- ² Requires externally mounted MMINT or PMINT module.
- ³ Test set for secondary injection.
- ⁴ Contact Eaton for availability.

I_r = Rating plug rating.
I_n = LDPU setting.

i Trip units are only used on IEC breakers with earth fault.

Catalog Number Selection

MWI Type Miscellaneous Accessories

Neutral Current Sensor

Catalog Number	Sensor Rating (A)	Catalog Number	Sensor Rating
9253C03H01	200	9253C03H08	1200
9253C03H02	250	9253C03H15	1250
9253C03H03	300	9253C03H09	1600
9253C03H04	400	9253C03H10	2000
9253C03H05	600	9253C03H11	2500
9253C03H14	630	9253C03H12	3000
9253C03H06	800	9253C03H16	3150
9253C03H07	1000	9253C03H13	3200

Mechanical Interlock Assembly Kits

Catalog Number	Type of Breaker	Interlock Kit Type	Comments
M12FR	Fixed	Rod Type 2	Kit also requires 1 Rod Kit
M12FC	Fixed	Cable Type 2	Kit also requires 1 Cable Kit
MI31FC	Fixed	Cable Type 31	Kit also requires 2 Cable Kits
MI32FC	Fixed	Cable Type 32	Kit also requires 3 Cable Kits
MI33FC	Fixed	Cable Type 33	Kit also requires 3 Cable Kits
M12DR	Drawout	Rod Type 2	Kit also requires 1 Rod Kit
M12DC	Drawout	Cable Type 2	Kit also requires 1 Cable Kit
MI31DC	Drawout	Cable Type 31	Kit also requires 2 Cable Kits
MI32DC	Drawout	Cable Type 32	Kit also requires 3 Cable Kits
MI33DC	Drawout	Cable Type 33	Kit also requires 3 Cable Kits

Cable Kits

Catalog Number	Comments
MIC5	Includes 2 Cables 1520 mm long (5 feet) each
MIC6	Includes 2 Cables 1830 mm long (6 feet) each
MIC8	Includes 2 Cables 2440 mm long (8 feet) each
MIC10	Includes 2 Cables 3050 mm long (10 feet) each

Cassette Cell Switch Kit

Catalog Number	Comments
M4CS	Cell switch, 4CO
M8CS	Cell switch, 8CO
M12CS	Cell switch, 12CO

Time Delay Undervoltage Module

Catalog Number	Comments
70C1316G01	120 VAC
70C1316G02	230 VAC

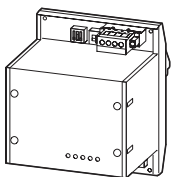

Communication Function of 520MC and 1150i Digitrip

Catalog Number	Comments	Rated control Voltage U_c V	Application range
PMINT	Converting module from INCOM protocol to PROFIBUS protocol, DIN mounting	—	Digitrip 520MC Digitrip 1150
MMINT	Converting module from INCOM protocol to MODBUS protocol, DIN mounting	—	Digitrip 520MC Digitrip 1150

Note: Miscellaneous accessories are not in 25 digit part numbers and need to be ordered separately.

3.3 Low Voltage Air Circuit Breakers

IZM Series MWI Type

Technical Data and Specifications

MWI Type ACB Options and Accessories

3 Breaker-Mounted Options and Accessories

Magnum breakers are available with a comprehensive array of factory-installed breaker options to enable configured-to-order solutions for specified customer requirements. Field option kits are available to provide easy service, modification and customization of the breaker at the point of use.

- Shunt Trip device (ST).** Provides for remote electrically controlled breaker opening when energized by a rated voltage input
- Spring Charge Motor (MOT).** Charges the breaker closing springs automatically, facilitating remote or local closing. The motor assembly includes its own cut-off switch that changes state at the end of the charging cycle. This contact can be wired out for external indication
- Spring Release device (SR).** Provides for remote electrically controlled breaker closing when its coils are energized by a rated voltage input
- Undervoltage Release (UVR).** Trips the breaker when an existing voltage signal is lost or falls below an established threshold
- Auxiliary Switch.** Up to 6a/6b auxiliary individual dedicated contacts are available for customer use to indicate if the breaker is in the OPEN or CLOSE position
- Mechanical Trip Indicator Flag.** The red trip indicator flag pops out to provide local visual indication when the Digitrip RMS trip unit acts to trip the breaker on an overcurrent condition. Available in two options: an interlocked version that mechanically locks out the breaker until the indicator is manually reset and a non-interlocked version for indication only.
- Bell Alarm/Overcurrent Trip Switch (OTS).** Provides 2 Form C (changeover) contacts that change state when the Digitrip RMS trip unit acts to trip the breaker on an overcurrent condition. The contacts are available for external indication or customer use and are manually reset by the Mechanical Trip Indicator
- Padlockable Pushbutton Cover.** Permits padlocking hinged cover plates to block access to the PUSH ON and PUSH OFF buttons on the breaker faceplate

- Mechanical Operations Counter.** Records mechanical operations of the breaker over its installed life
- Key Off Lock Provisions.** Enables mounting of a single cylinder Kirk®, Castell or Ronis key lock to lock the breaker in the OPEN position
- Latch Check Switch.** Provides 1 Form C (changeover contact) that changes state when the breaker is ready to close. Can be wired to the Spring Release Device for fast transfer applications or wired for external ready-to-close indication



Shunt Trip, Spring Release and Undervoltage Release Device Installed on Accessory Deck



Auxiliary Switches Come in Modular 2a/2b Contact Stages Providing up to 6a/6b Dedicated Contacts



Arc Chutes are Easily Removable for Inspection and Access to Breaker Contacts



Heel-Toe Contact Design Provides Demonstrated Long Life and Includes Wear Indicator for Visual Inspection



Mechanical Trip Indicator With Bell Alarm (OTS) Switches Mounted

Technical Data and Specifications

MWI Type ACB Control Device Application Guide—Vdc

Breaker Control Device Nominal Voltage	24 Vdc	32 Vdc	48 Vdc	60 Vdc	125 Vdc	250 Vdc	
Shunt Trip (ST)—Trip Circuit							
Operational voltage range	70–110%	17–26 Vdc	—	34–53 Vdc	42–66 Vdc	77–138 Vdc	154–275 Vdc
Power consumption (inrush)	Required for 35 ms ¹	250W	—	250W	250W	450W	450W
Opening time	Seconds	35 ms	—	35 ms	35 ms	35 ms	35 ms
Spring Release (SR)—Close Circuit							
Operational voltage range	70–110%	17–26 Vdc	—	34–53 Vdc	42–66 Vdc	77–138 Vdc	154–275 Vdc
Power consumption (inrush)	Required for 200 ms	250W	—	250W	250W	450W	450W
Closing time	Seconds	40 ms	—	40 ms	40 ms	40 ms	40 ms
Spring Charge Motor (MOT)							
Operational voltage range	85–110% voltage	20–26 Vdc	—	41–53 Vdc	51–66 Vdc	94–138 Vdc	187–225 Vdc
Amperes (running)	Running	12.0A	—	5.0A	4.0A	2.0A	1.0A
Amperes (inrush)	% of running	300%	—	500%	500%	600%	600%
Power consumption	—	300W	—	250W	250W	250W	250W
Charging time	Seconds	5 sec	—	5 sec	5 sec	5 sec	5 sec
Undervoltage Release (UVR)							
Operational voltage range	85–110% voltage	20–26 Vdc	27–35 Vdc	41–53 Vdc	51–66 Vdc	94–138 Vdc	187–275 Vdc
Dropout voltage range	30–60% voltage	7–14 Vdc	10–19 Vdc	14–29 Vdc	18–36 Vdc	33–75 Vdc	66–150 Vdc
Power consumption (inrush)	Required for 200 ms	250W	275W	275W	275W	450W	450W
Power consumption (continuous)	Required for 400 ms	18W	15W	18W	18W	10W	10W
Opening time	Seconds	70 ms	70 ms	70 ms	70 ms	70 ms	70 ms
Auxiliary Switches							
Minimum load contact rating	Inductive load	0.5A	—	0.5A	—	0.5A	0.25A

MWI Type ACB Control Device Application Guide—Vac

Breaker Control Device Nominal Voltage	120 Vac	240 Vac	415 Vac	
Shunt Trip (ST)—Trip Circuit				
Operational voltage range	70–110%	77–140 Vac	146–264 Vac	—
Power consumption (inrush)	Required for 35 ms	450 VA	450 VA	—
Opening time	Seconds	35 ms	35 ms	—
Spring Release (SR)—close circuit				
Operational voltage range	70–110%	77–140 Vac	146–264 Vac	—
Power consumption (inrush)	Required for 200 ms	450 VA	450 VA	—
Closing time	Seconds	40 ms	40 ms	—
Spring Charge Motor (MOT)				
Operational voltage range	85–110% voltage	93–140 Vdc	177–264 Vdc	—
Amperes (running)	Running	2.0A	1.0A	—
Amperes (inrush)	% of running	600%	600%	—
Power consumption	—	250 VA	250 VA	—
Charging time	Seconds	5 sec	5 sec	—
Undervoltage Release (UVR)				
Operational voltage range	85–110% voltage	94–140 Vac	177–264 Vac	323–457 Vac
Dropout voltage range	30–60% voltage	33–76 Vac	62–144 Vac	114–249 Vac
Power consumption (inrush)	Required for 200 ms	450 VA	400 VA	480 VA
Power consumption (continuous)	Required for 400 ms	10 VA	10 VA	10 VA
Opening time	Seconds	70 ms	70 ms	70 ms
Auxiliary Switches				
Minimum load contact rating	Inductive load	10A	10A	—

Note

¹ 100% duty shunt trips require power consumption (inrush) for 200 ms.

3.4 Low Voltage Air Circuit Breakers

IZM Series MWI Type

Dimensions

MWI Type Fixed 800-3200A

MWI...F...

3

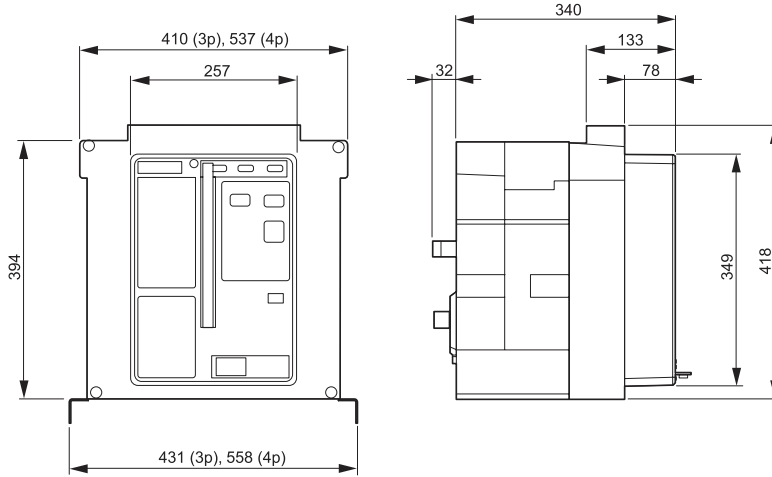

A: Minimum cabinet size recommended (not to scale)

MWI Type Neutral Conductor Current Transformer

Type	Current rating
H01	200:1
H02	250:1
H03	300:1
H04	400:1
H05	600:1
H06	800:1
H07	1000:1
H08	1200:1
H09	1600:1
H10	2000:1
H11	2500:1
H12	3000:1
H13	3200:1
H14	630:1
H15	1250:1
H16	3150:1
H17	4000:1
H18	100:1

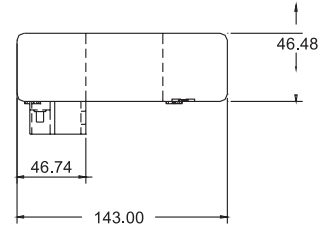
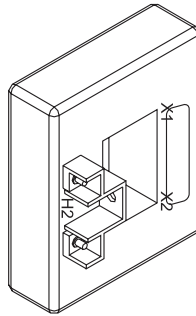

In full scale, all 2nd current rated value is 1.00A.
 Insulation degree: 0.6kV, BIL: 10kV(full wave)
 Non-interruptive current rated value factor:
 1.33 (ambient temperature at 30 degree)
 1.0 (ambient temperature at 55 degree)

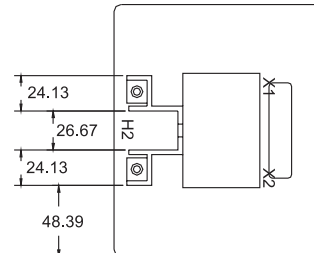
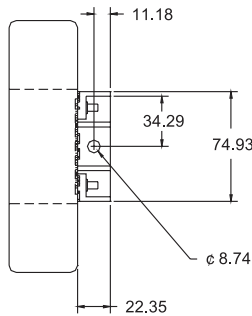

Dimensions

MWI Type Drawout 800-3200A

MWI...W...

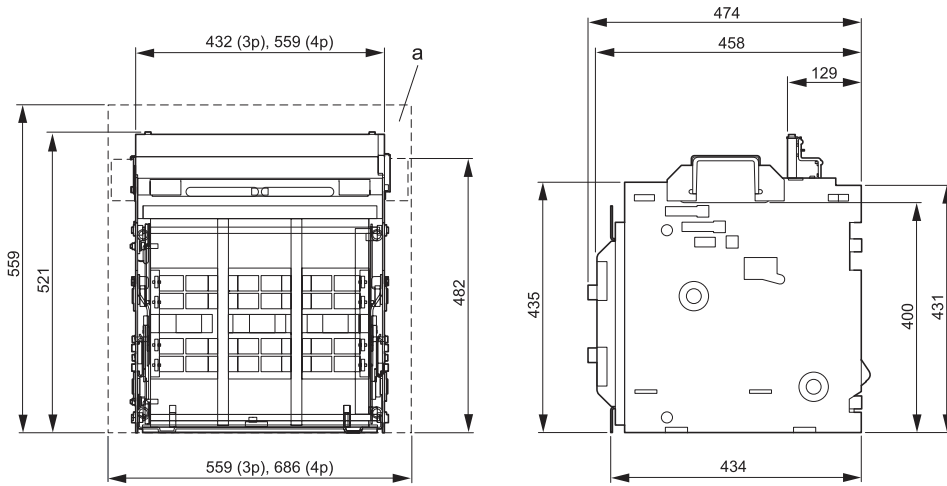

MWI Type Drawout 4000A

MWI...W...

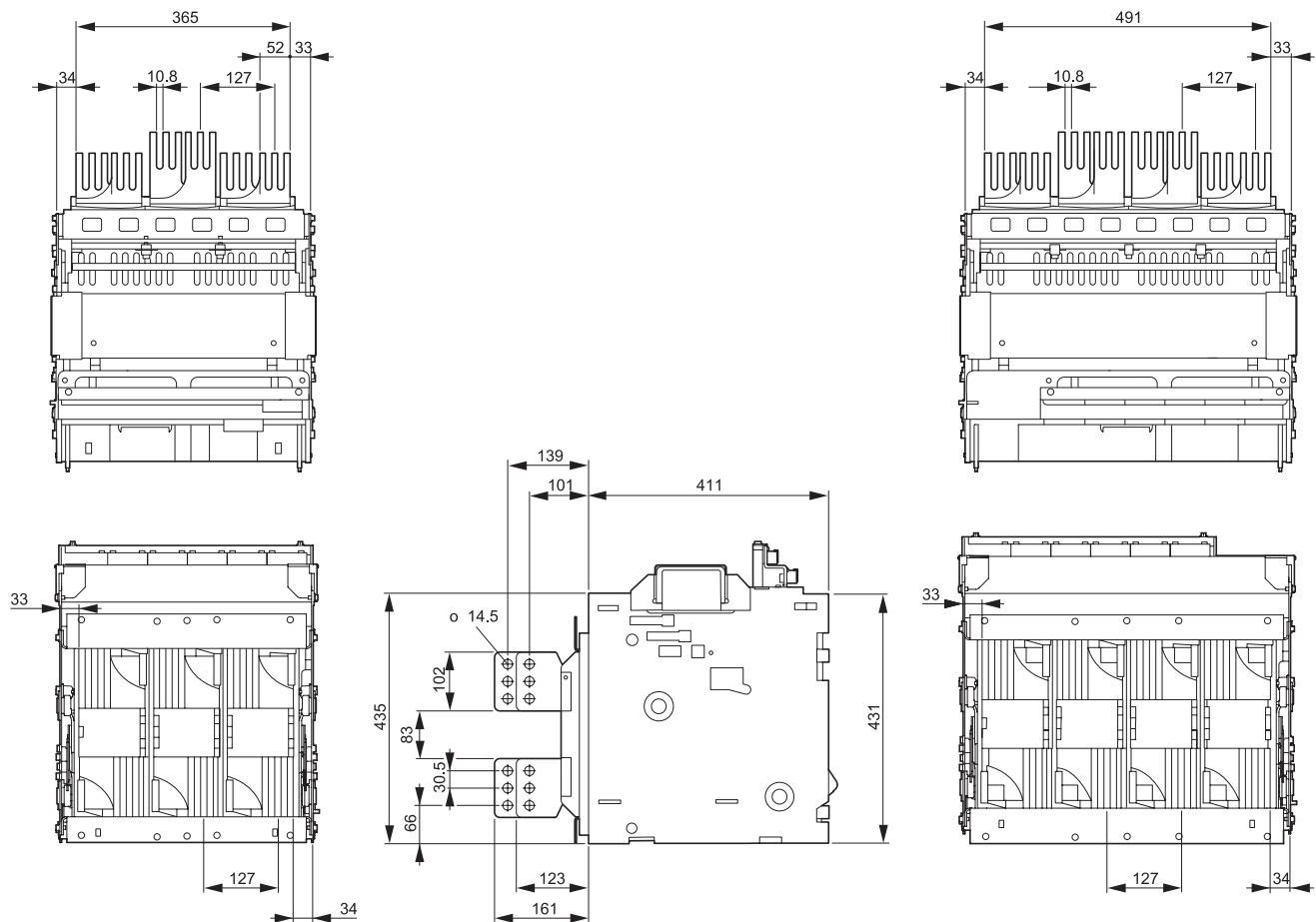

3.4 Low Voltage Air Circuit Breakers

IZM Series MWI Type

Dimensions

MWI Type(Double-wide frame) Fixed 4000A-6300A

MWI...W...

3

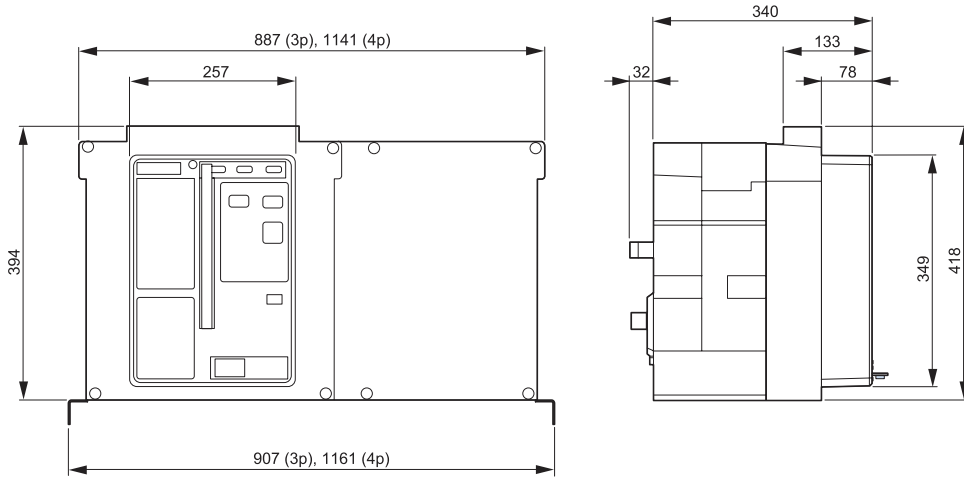

MWI Type(Double-wide frame) Withdrawable 4000A-6300A

MWI...W...

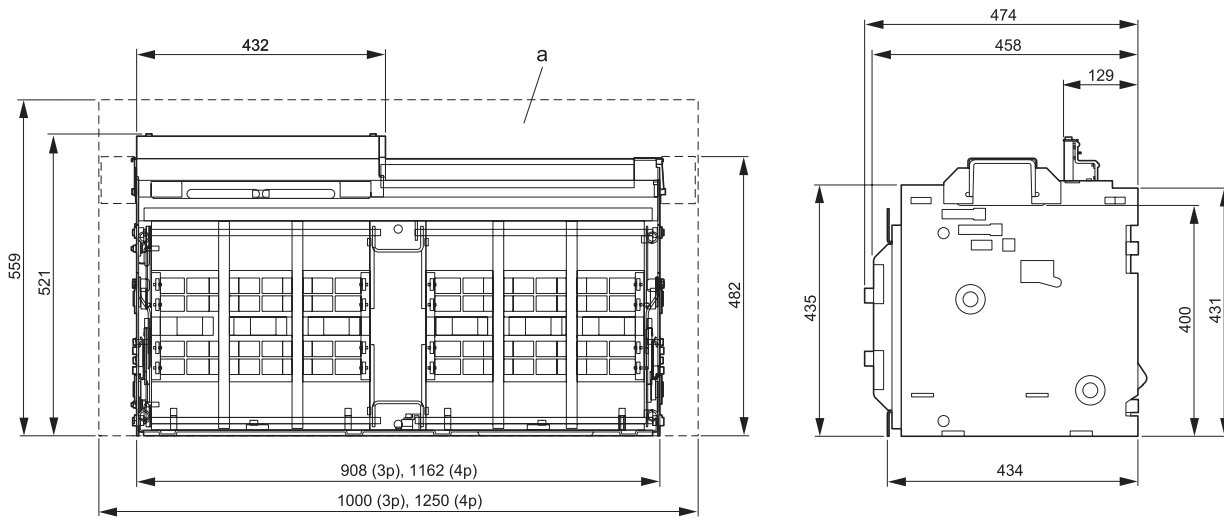

A: Minimum cabinet size recommended (not to scale)

Wiring Diagrams

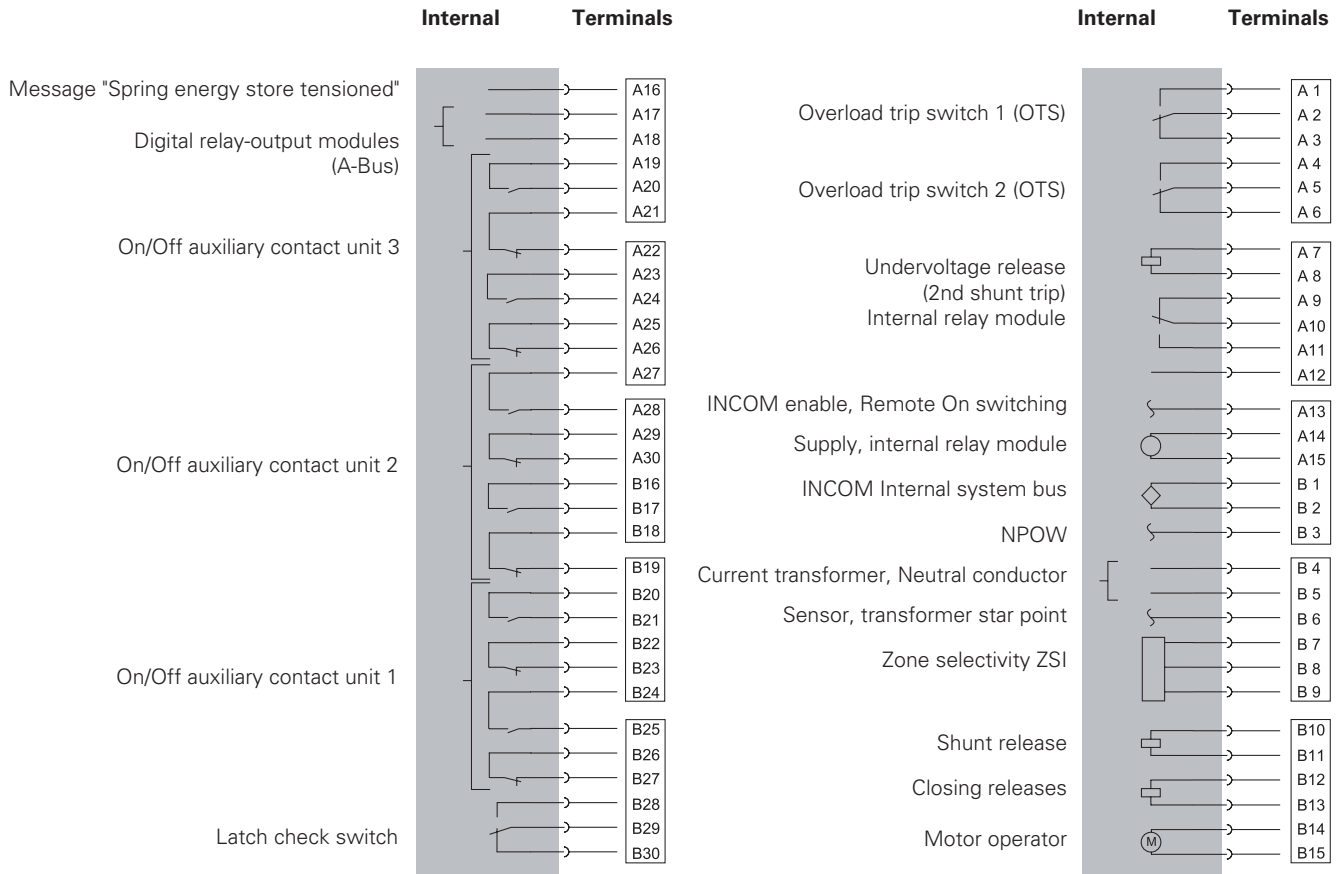

3.5 Low Voltage Air Circuit Breakers

IzM Series MWI Type

Wiring Diagrams

Typical MWI Type Control Circuit

3

Legend:

- LS Limit Switch for Closing Spring
- MOT Motor for Spring Charging
- ST Shunt Trip¹
- SR Spring Release
- UVR Undervoltage Release
- OTS Overcurrent Trip Switch

Description of Operation:

- 1 — Motor is energized through LS contact.
- 2 — Motor runs and charges closing spring.
- 3 — When closing spring is fully charged, LS contacts change state.
- 4 — Close contacts energize SR coil.
- 5 — When breaker closes, "b" opens.
- 6 — LS contacts change state and motor recharges closing springs.

Notes

- * Contacts shown for breaker open (not fully charged), not tripped.
- Dotted line denotes MWI Breaker.
- ¹ Not needed with 100% duty rated shunt.

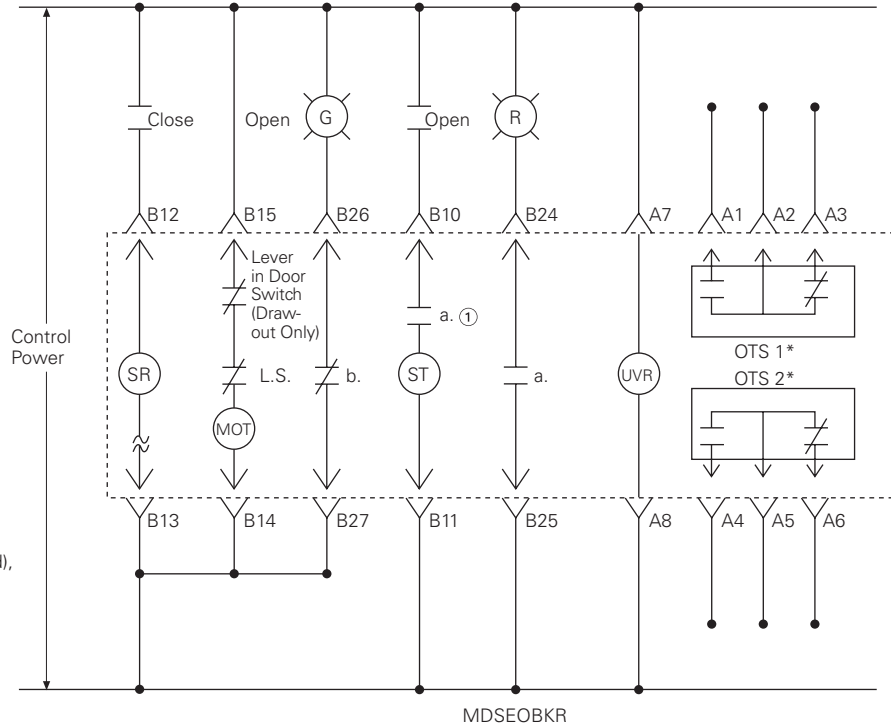

Eaton Corporation plc is a diversified power management company providing energy-efficient solutions that help our customers effectively manage electrical, hydraulic and mechanical power. The company is a global technology leader in electrical products, systems and services for power quality, distribution and control, power transmission, lighting and wiring products; hydraulics components, systems and services for industrial and mobile equipment; aerospace fuel, hydraulics and pneumatic systems for commercial and military use; and truck and automotive drivetrain and powertrain systems for performance, fuel economy and safety. Eaton acquired Cooper Industries plc in 2012. The new company, Eaton Corporation plc, has approximately 100,000 employees and sells products to customers in more than 150 countries. For more information, visit www.eaton.com/SEAsia

Electrical Sector Asia Pacific
No.3, Lane 280, Linhong Road,
Changning District, Shanghai

Eaton Industries Pte Ltd
Electrical Sector
4 Loyang Lane #04-01/02
Singapore 508914
www.eaton.com/SEAsia

© 2014 Eaton Corporation
All Rights Reserved
Printed in Singapore
Publication No. SEACA0102003
January 2014

Eaton is a registered trademark
of Eaton Corporation.

All other trademarks are property
of their respective owners.